

SURGICAL TECHNIQUE

## CCS

Cannulated Compression Screws

1.7, 2.2, 3.0, 4.0, 5.0, 7.0

## headedCCS

Headed Cannulated Compression Screws

2.2, 3.0, 4.0, 5.0, 7.0



# Contents

3	Introduction
3	Product Materials
3	Indications
3	Contraindications
3	Warning
3	Color Coding
3	Symbols
4	System Overview
7	Treatment Concept
8	Surgical Techniques
8	General Surgical Techniques
8	CCS 1.7, 2.2, 3.0 and headed CCS 2.2, 3.0
13	CCS 4.0, 5.0, 7.0 and headed CCS 4.0, 5.0, 7.0
20	Specific Surgical Techniques
20	Click-on Parallel K-Wire Guide
21	Drill Stop
23	Protecting Soft Tissue During Screw Insertion
23	Determining Soft Tissue Thickness
24	Explanation
25	Implants, Instruments and Containers

For further information regarding the APTUS product line visit [www.medartis.com](http://www.medartis.com)

# Introduction

## Product Materials

Product	Material
Washers	Titanium alloy
Screws	Titanium alloy
K-wires	Stainless steel
Instruments	Stainless steel, PEEK, aluminum, Nitinol, silicone or titanium
Containers	Stainless steel, aluminum, PEEK, polyphenylsulfone, polyurethane, silicone

## Indications

Fractures, osteotomies and arthrodesis of bones with the appropriate screw size

## Contraindications

- Preexisting or suspected infection at or near the implantation site
- Known allergies and/or hypersensitivity to implant materials
- Inferior or insufficient bone quality to securely anchor the implant
- Patients who are incapacitated and/or uncooperative during the treatment phase
- Growth plates are not to be blocked with plates and screws

## Warning

- In patients with Charcot foot and/or other neuropathic diseases, the CCS 4.0, 5.0, 7.0 and headedCCS 4.0, 5.0, 7.0 are not to be used as stand-alone implants. They need to be used with supplemental fixation, such as additional screws and plates, across the fused joints.

## Caution

- CCS and headedCCS screws have sharp threads and need to be picked up from the implant container by means of the screwdriver. Be cautious touching the screws directly.
- Screws are not to be positioned in the joint gap (exception: arthrodesis).

## Color Coding

System Size	Color Code
APTUS 1.7	Turquoise
APTUS 2.2	Purple
APTUS 3.0	Yellow
APTUS 4.0	Brown
APTUS 5.0	Dark blue
APTUS 7.0	Turquoise

## Plates and Screws

Special implant plates and screws have their own color:  
 Implant screws gold      CCS and headedCCS  
 Implant plates gold      Washers for headedCCS

## Possible Combination of Plates and Screws

Plates and screws can be combined within one system size.

## Symbols











HexaDrive























See Instructions for Use  
[www.medartis.com](http://www.medartis.com)

# System Overview

Cannulated screws and headed cannulated screws are available with short thread, long thread or fully threaded in different diameters and lengths.

Description	Example	Main Feature	Compression	Screw Length (Increment)
CCS 1.7	 A-5281.xx	Long distal thread	Yes	8 – 16 mm (1 mm), 18 – 20 mm (2 mm)
	 A-5282.xx	Fully threaded	No	6 – 16 mm (1 mm)
CCS 2.2	 A-5780.xx	Short distal thread	Yes	10 – 30 mm (1 mm)
	 A-5781.xx	Long distal thread	Yes	22 – 40 mm (2 mm)
headedCCS 2.2	 A-5785.xx	Short distal thread	Yes	10 – 30 mm (1 mm), 32 – 40 mm (2 mm)
	 A-5786.xx	Long distal thread	Yes	20 – 30 mm (1 mm), 32 – 40 mm (2 mm)
CCS 3.0	 A-5880.xx	Short distal thread	Yes	10 – 30 mm (1 mm), 32 – 40 mm (2 mm)
	 A-5881.xx	Long distal thread	Yes	26 – 40 mm (2 mm)

Description	Example	Main Feature	Compression	Screw Length (Increment)
headedCCS 3.0	 <p>A-5885.xx</p>	Short distal thread	Yes	10 – 30 mm (1 mm), 32 – 40 mm (2 mm)
	 <p>A-5886.xx</p>	Long distal thread	Yes	20 – 30 mm (1 mm), 32 – 40 mm (2 mm)
CCS 4.0	 <p>A-8110.xx</p>	Short distal thread	Yes	16 – 50 mm (2 mm), 55 – 60 mm (5 mm)
	 <p>A-8111.xx</p>	Long distal thread	Yes	20 – 50 mm (2 mm), 55 – 60 mm (5 mm)
	 <p>A-8112.xx</p>	Fully threaded	No	16 – 50 mm (2 mm), 55 – 60 mm (5 mm)
headedCCS 4.0	 <p>A-8115.xx</p>	Short distal thread	Yes	16 – 50 mm (2 mm), 55 – 60 mm (5 mm)
	 <p>A-8116.xx</p>	Long distal thread	Yes	20 – 50 mm (2 mm), 55 – 60 mm (5 mm)
	 <p>A-8117.xx</p>	Fully threaded	No	16 – 50 mm (2 mm), 55 – 60 mm (5 mm)
CCS 5.0	 <p>A-8210.xx</p>	Short distal thread	Yes	24 – 40 mm (2 mm), 45 – 70 mm (5 mm)
	 <p>A-8211.xx</p>	Long distal thread	Yes	30 – 40 mm (2 mm), 45 – 70 mm (5 mm)
	 <p>A-8212.xx</p>	Fully threaded	No	24 – 40 mm (2 mm), 45 – 70 mm (5 mm)

Description	Example	Main Feature	Compression	Screw Length (Increment)
headedCCS 5.0	 <p>A-8215.xx</p>	Short distal thread	Yes	24 – 40 mm (2 mm), 45 – 70 mm (5 mm)
	 <p>A-8216.xx</p>	Long distal thread	Yes	30 – 40 mm (2 mm), 45 – 70 mm (5 mm)
	 <p>A-8217.xx</p>	Fully threaded	No	24 – 40 mm (2 mm), 45 – 70 mm (5 mm)
CCS 7.0	 <p>A-8410.xx</p>	Short distal thread	Yes	30 – 110 mm (5 mm), 120 – 140 mm (10 mm)
	 <p>A-8411.xx</p>	Long distal thread	Yes	35 – 110 mm (5 mm), 120 – 140 mm (10 mm)
	 <p>A-8412.xx</p>	Fully threaded	No	30 – 110 mm (5 mm), 120 – 140 mm (10 mm)
headedCCS 7.0	 <p>A-8415.xx</p>	Short distal thread	Yes	30 – 110 mm (5 mm), 120 – 140 mm (10 mm)
	 <p>A-8416.xx</p>	Long distal thread	Yes	35 – 110 mm (5 mm), 120 – 140 mm (10 mm)
	 <p>A-8417.xx</p>	Fully threaded	No	30 – 110 mm (5 mm), 120 – 140 mm (10 mm)

For the complete implant portfolio, please refer to chapter “Implants, Instruments and Containers”.

# Treatment Concept

The following lists typical clinical findings which can be treated with APTUS Cannulated Compression Screws and headed Cannulated Compression Screws.

## Shoulder

Fractures

- of the proximal humerus
- of the glenoid

3.0 4.0 5.0



## Elbow

Fractures

- of the distal humerus
- of the proximal ulna
- of the proximal radius

2.2 3.0 4.0



## Wrist

Fractures

- of the radius
- of the ulna

Fractures and arthrodesis

- of the carpal bones

1.7 2.2 3.0 4.0



## Hand

Fractures, arthrodesis and osteotomies

- of the phalanges
- of the metacarpals
- of the carpals

## Knee

Fractures

- of the proximal tibia
- of the patella
- of the distal femur

4.0 5.0 7.0



## Foot and Ankle

Fractures, arthrodesis and osteotomies

- of the ankle joint
- of the subtalar joint
- of the hindfoot
- of the midfoot
- of the forefoot

2.2 3.0 4.0 5.0 7.0



The above-mentioned information is a recommendation only.  
The operating surgeon is solely responsible for the choice of the suitable implant for the specific case.

# Surgical Techniques

## General Surgical Techniques

CCS 1.7, 2.2, 3.0 and headedCCS 2.2, 3.0

### 1. Selecting the K-wire

Select the required K-wire diameter depending on the screw size and verify the diameter in the container.

#### Caution

To ensure that the lengths of the screws to be used are assigned correctly, only original APTUS K-wires may be used. If alternative wires are used, the correct screw length selection cannot be assured.



### 2. Protecting the soft tissue

Position the drill guide or K-wire guide/protection sleeve with the side marked "K-WIRE" onto the bone.





## CCS 1.7, 2.2, 3.0 and headedCCS 2.2, 3.0

Art. No	For Screws	Guides / Soft Tissue Protection for
A-2225	CCS 1.7	K-wire Drill Countersink Screw
A-2725	CCS 2.2	K-wire Drill Countersink
A-2825	CCS 3.0	K-wire Drill Countersink
A-2039	CCS 2.2 CCS 3.0	Screw
A-2824	CCS 2.2 CCS 3.0 headedCCS 2.2 headedCCS 3.0	K-wire Drill Countersink Screw
A-2007	CCS 2.2 CCS 3.0 headedCCS 2.2 headedCCS 3.0	K-wire, percutaneous

**3. Placing the K-wire**

Place the K-wire perpendicularly to the fracture or osteotomy line. Do not forcefully insert the K-wire as it may bend.

**Caution**

Use X-ray control to verify the correct position of the K-wire.

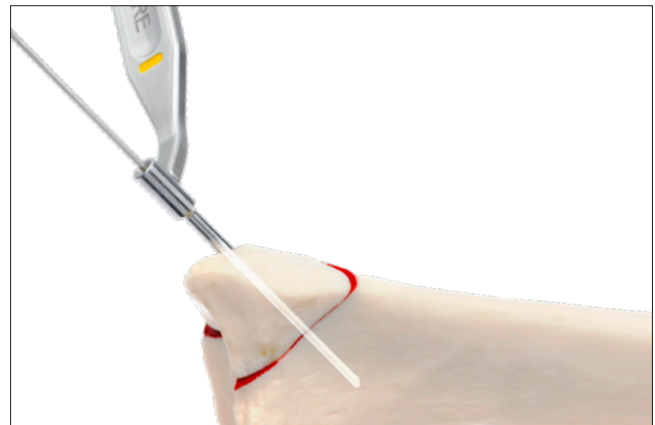

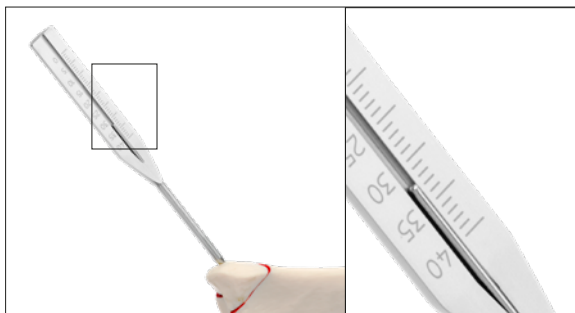
**CCS 1.7, 2.2, 3.0****4. Determining the required screw length**

Remove the drill guide resp. K-wire guide/protection sleeve. Slide the depth gauge (A-2235, A-2835) over the K-wire until it touches the bone. The length can be read from the end of the K-wire.

**5A. Drilling – optional**

The screw can be implanted directly without predrilling.

**Caution**

In the case of particularly hard bone (e.g. intramedullary fixation) it is mandatory to predrill over the length of the screw. This prevents the risk of the screw running up against very hard bone structure and at worst breaking.



Use the color-coded cannulated twist drill (A-3236, A-3736, A-3836).

The twist drill must always be guided by a drill guide (A-2725, A-2825) or a K-wire guide/protection sleeve (A-2225, A-2824). This protects the surrounding tissue from direct contact with the drill. Position the drill guide or the K-wire guide/protection sleeve with the side marked "DRILL" or "INSTRUMENTS" onto the bone.

**Caution**

Do not drill beyond the tip of the K-wire, as the K-wire will no longer have purchase in the bone.

**5B. Countersinking – optional**

Use the color-coded countersink (A-3932, A-3937, A-3938) to predrill the near cortex.

**headedCCS 2.2, 3.0****4A. Drilling – optional**

The screw can be implanted directly without predrilling.

**Caution**

In the case of particularly hard bone (e.g. intramedullary fixation) it is mandatory to predrill over the length of the screw. This prevents the risk of the screw running up against very hard bone structure and at worst breaking.



Use the color-coded cannulated twist drill (A-3836). The twist drill must always be guided by a K-wire guide/protection sleeve (A-2824). This protects the surrounding tissue from direct contact with the drill. Position the K-wire guide/protection sleeve with the side marked "DRILL" or "INSTRUMENTS" onto the bone.

**Caution**

Do not drill beyond the tip of the K-wire, as the K-wire will no longer have purchase in the bone.

**4B. Countersinking – optional**

Use the color-coded countersink (A-3935, A-3936) to predrill the near cortex.

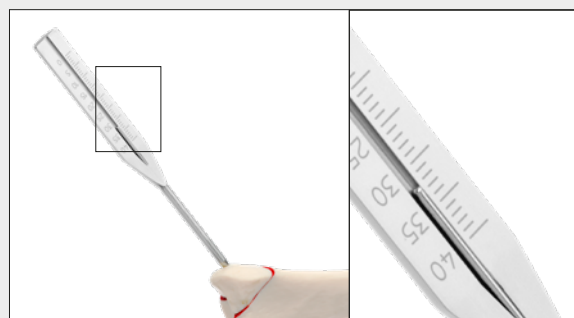
**5. Determining the required screw length**

The K-wire guide/protection sleeve can be left in place. Slide the depth gauge (A-2835) over the K-wire until it touches the bone. The length can be read from the end of the K-wire.

## CCS 1.7, 2.2, 3.0 and headedCCS 2.2, 3.0

### 6. Selecting the screw

Select a screw that is slightly shorter than the length determined in Step 4 (for CCS) or Step 5 (for headedCCS) to allow for shortening through compression of the fracture gap.

#### Warning

When selecting the screw, it is mandatory that the distal thread is not positioned within the fracture gap, as otherwise no compression can be achieved.

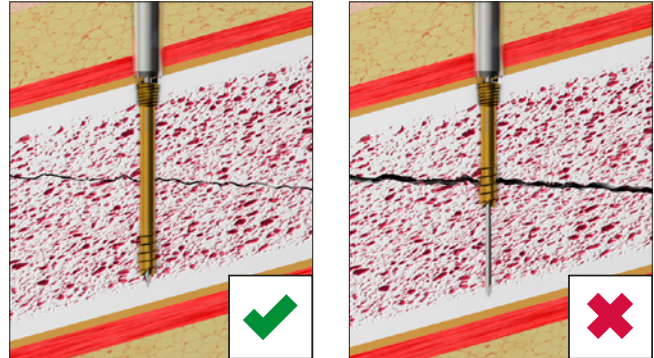

### Fully threaded screws

As these screws do not compress, the thread can be positioned after reduction within the fracture gap. If compression of the fracture gap is desired, then a partially threaded screw has to be inserted first. Only afterwards a fully threaded screw may be inserted for stabilization.

### 7. Picking up the screw

#### Caution

CCS and headedCCS have sharp threads and need to be picked up from the implant container by means of the screwdriver. Be cautious touching the screws directly.

To remove the screws from the implant container, insert the appropriately color-coded screwdriver blade perpendicularly into the screw head of the desired screw and pick up the screw with axial pressure.

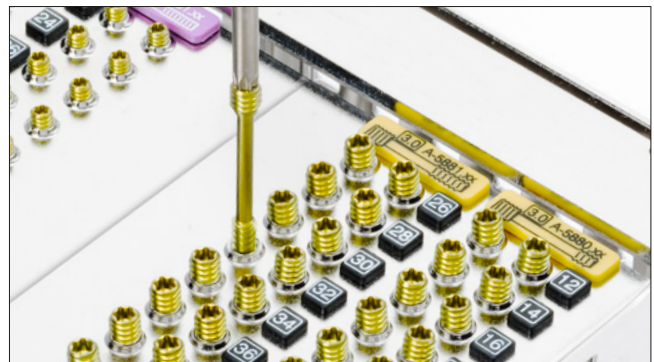

#### Caution

The screw will not hold without axial pressure!

Vertically extract the screw from the compartment.

#### Caution

Picking up the screw repeatedly may lead to permanent deformation of the self-retaining area of the HexaDrive inside the screw head. Therefore, the screw may no longer be able to be picked up correctly. In this case, a new screw has to be used.



Check the screw length and diameter at the scale of the measuring module. The screw length is determined at the end of the screw head.



## CCS 1.7, 2.2, 3.0 and headedCCS 2.2, 3.0

### 8A. Inserting the screw

#### Caution

CCS and headedCCS have sharp threads. Be cautious touching the screws directly.

CCS 2.2, 3.0:

Remove the drill guide (A-2725, A-2825).

CCS 1.7, 2.2, 3.0 and headedCCS 2.2, 3.0:

The K-wire guide/protection sleeve (A-2225, A-2824) can be left in place.

headedCCS 2.2, 3.0:

Optionally, a washer (A-4700.71, A-4800.70) can also be used to achieve a larger contact surface between screw head and bone.

When inserting the screw, apply sufficient axial pressure in order to allow for proper cutting and good thread forming.

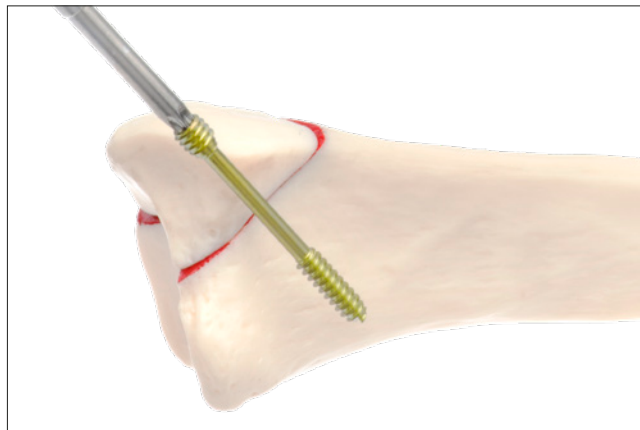

### 8B. Sinking the screw head

CCS 1.7, 2.2, 3.0:

#### Caution

Turn the screw until the screw head is completely inserted into the bone.

Remove the K-wire.

#### Warning

The correct position of the screw, screw head and screw tip as well as the screw length always have to be verified using X-ray control.



## CCS 4.0, 5.0, 7.0 and headedCCS 4.0, 5.0, 7.0

### 1. Selecting the K-wire

Select the required K-wire diameter depending on screw size and verify the diameter in the container's measuring module.

#### Caution

To ensure that the lengths of the screws to be used are assigned correctly, only original APTUS K-wires may be used. If alternative wires are used, the correct screw length selection cannot be assured.



### 2. Protecting the soft tissue

Connect the color-coded protection sleeve (A-8004.23, A-8000.23, A-8001.23) to the cannulated handle with quick coupling AO or AO Large (A-2077, A-8000.20, A-8001.10).



CCS 4.0, headedCCS 4.0

CCS 5.0, headedCCS 5.0

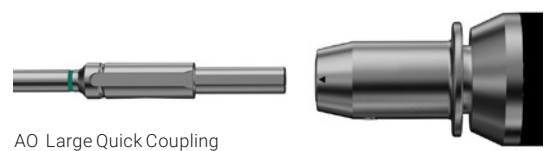
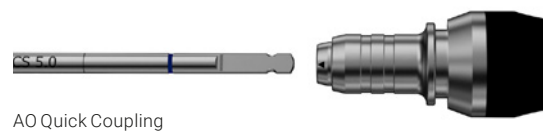

CCS 7.0, headedCCS 7.0



## CCS 4.0, 5.0, 7.0 and headedCCS 4.0, 5.0, 7.0

Slide the K-wire guide (A-8004.25, A-8000.25, A-8001.25) and the trocar (A-8004.24, A-8000.24, A-8001.24) into the protection sleeve.

Place the protection sleeve onto the bone.

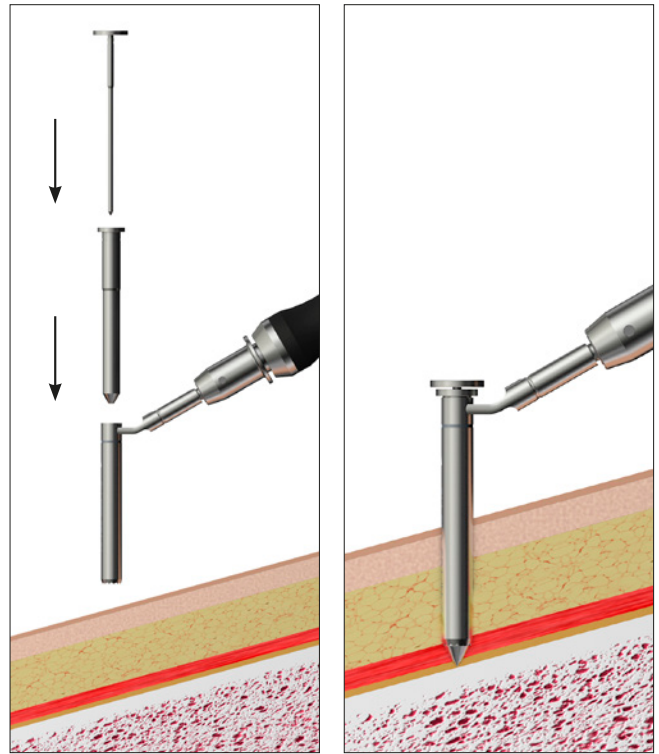

In case the trocar (A-8004.24, A-8000.24, A-8001.24) was used, pull it off with a slight turning and pulling movement.

In case the K-wire guide (A-8004.25, A-8000.25, A-8001.25) loosens, it needs to be moved back.

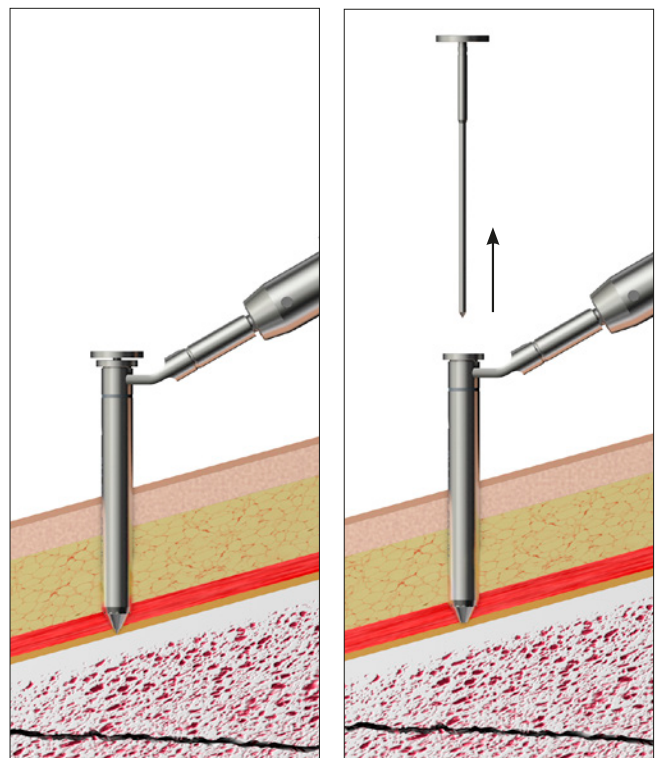

CCS 4.0, 5.0, 7.0 and headedCCS 4.0, 5.0, 7.0

### 3. Placing the K-wire

Place the K-wire perpendicularly to the fracture or osteotomy line. Do not forcefully insert the guide wire as it may bend.

#### Caution

Use X-ray control to verify the correct position of the K-wire.

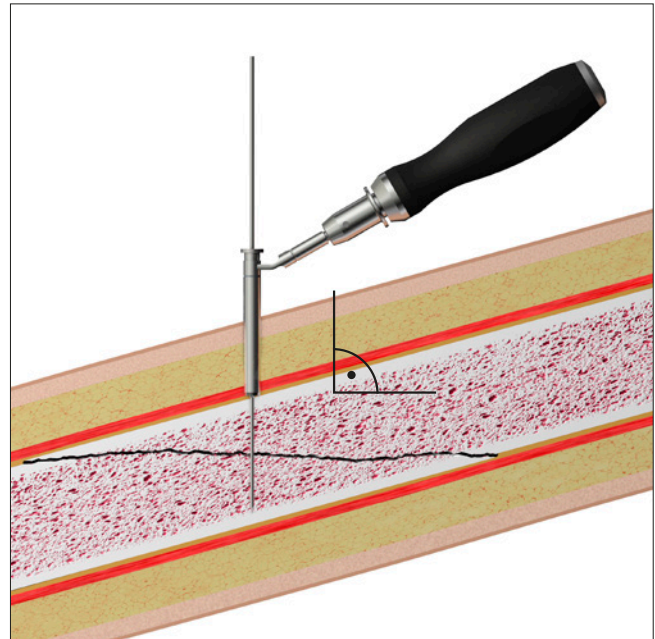

## CCS 4.0, 5.0, 7.0

### 4. Determining the required screw length

Remove the K-wire guide (A-8004.25, A-8000.25, A-8001.25).  
Slide the depth gauge (A-8004.27, A-8000.27, A-8001.27) over the K-wire until it touches the bone. The length can be read from the end of the K-wire.

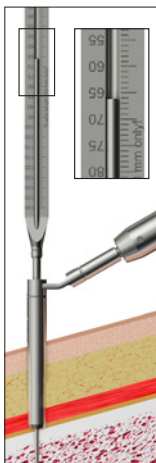

### 5A. Drilling – optional

Predrill with the color-coded twist drill (A-8004.01, A-8000.03, A-8001.01) over the K-wire through the protection sleeve.

The twist drill must always be guided by a protection sleeve. This protects the surrounding tissue from direct contact with the drill.

#### Caution

Do not drill beyond the tip of the K-wire, as the K-wire will no longer have purchase in the bone.

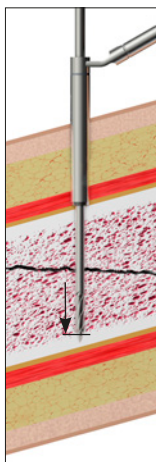

### 5B. Countersinking – optional

Drill the first cortex with the color-coded countersink (A-8004.02, A-8000.04, A-8001.02) over the K-wire through the protection sleeve.

#### Caution

The use of twist drills and/or countersinks is recommended in the case of particularly hard bone.

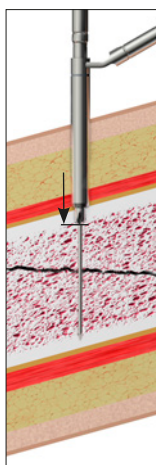

## headedCCS 4.0, 5.0, 7.0

### 4A. Drilling – optional

Remove the K-wire guide (A-8004.25, A-8000.25, A-8001.25).  
Predrill with the color-coded twist drill (A-8004.01, A-8000.03, A-8001.01) over the K-wire through the protection sleeve.

The twist drill must always be guided by a protection sleeve. This protects the surrounding tissue from direct contact with the drill.

#### Caution

Do not drill beyond the tip of the K-wire, as the K-wire will no longer have purchase in the bone.

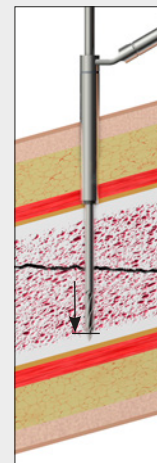

### 4B. Countersinking – optional

Drill the first cortex with the color-coded countersink (A-8004.03, A-8000.05, A-8001.03) over the K-wire through the protection sleeve.

#### Caution

The use of twist drills and/or countersinks is recommended in the case of particularly hard bone.

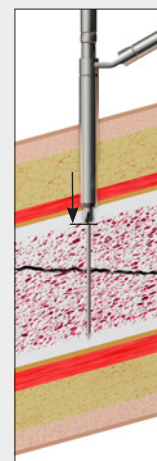

### 5. Determining the required screw length

Slide the depth gauge (A-8004.27, A-8000.27, A-8001.27) over the K-wire until it touches the bone. The length can be read from the end of the K-wire.

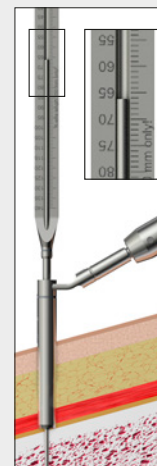



## CCS 4.0, 5.0, 7.0 and headedCCS 4.0, 5.0, 7.0

### 6. Selecting the screw

Select a screw that is slightly shorter than the length determined in Step 4 (for CCS) and Step 5 (for headedCCS) to allow for shortening of the fracture gap through compression.

### Warning

When selecting the screw, it is essential that the distal thread is not positioned within the fracture gap, as otherwise no compression can be achieved.

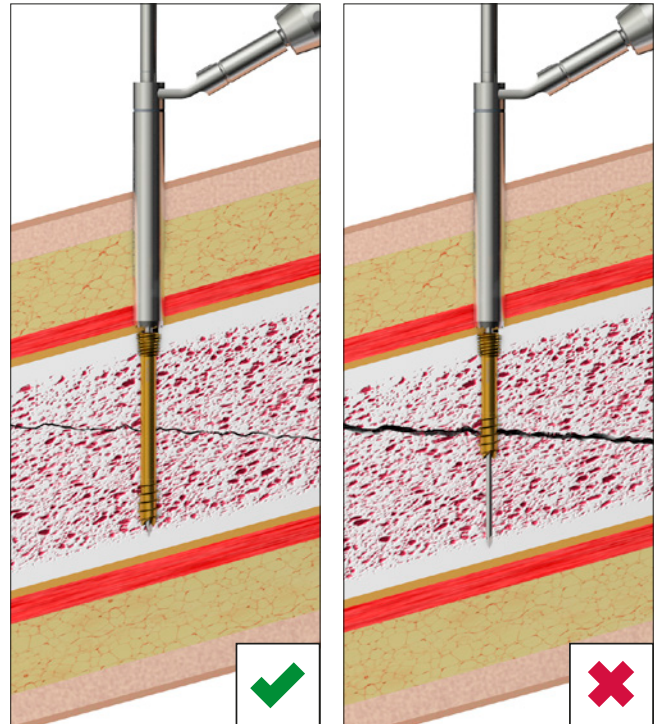

### Fully threaded screws

As these screws do not compress, the thread can be positioned after reduction within the fracture gap. If compression of the fracture gap is desired, then a partially threaded screw has to be inserted first. Only afterwards a fully threaded screw may be inserted for stabilization.

## CCS 4.0, 5.0, 7.0 and headedCCS 4.0, 5.0, 7.0

### 7. Picking up the screw

#### Caution

CCS and headedCCS have sharp threads and need to be picked up from the implant container by means of the screwdriver. Be cautious touching the screws directly.

To remove the screws from the implant container, insert the appropriately color-coded screwdriver blade perpendicularly into the screw head of the desired screw and pick up the screw with axial pressure.

#### Caution

The screw will not hold without axial pressure!

Vertically extract the screw from the compartment.

#### Caution

Picking up the screw repeatedly may lead to permanent deformation of the self-retaining area of the HexaDrive inside the screw head. Therefore, the screw may no longer be able to be picked up correctly. In this case, a new screw has to be used.

Check the screw length and diameter at the scale of the measuring module. The screw length is determined at the end of the screw head.

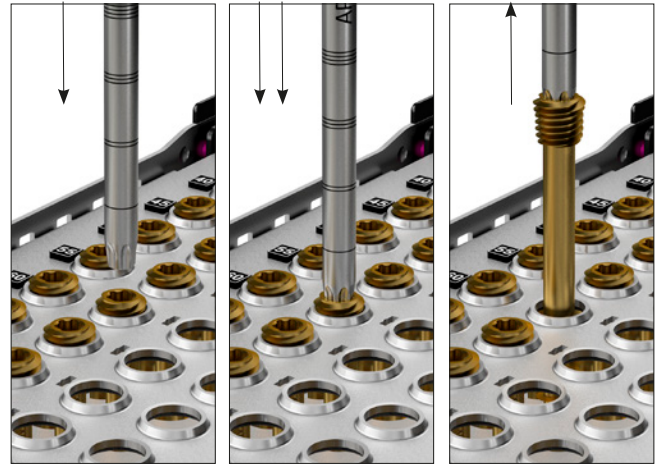

### 8A. Inserting the screw

#### Caution

CCS and headedCCS have sharp threads. Be cautious touching the screws directly.

headedCCS 4.0, 5.0, 7.0:

Optionally, a washer (A-8140.70, A-8240.70, A-8440.70) can also be used to achieve a larger contact surface between screw head and bone.

#### Warning

Use the protection sleeve while inserting the screws.

When inserting the screw, apply sufficient axial pressure in order to allow for proper cutting and good thread forming.

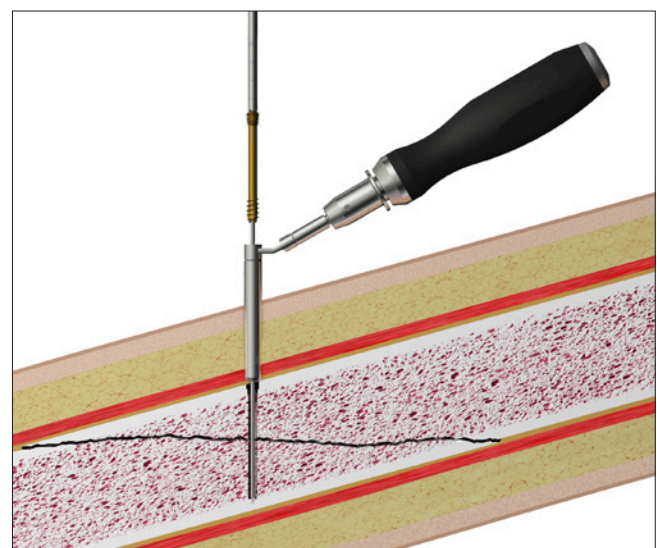

## CCS 4.0, 5.0, 7.0 and headedCCS 4.0, 5.0, 7.0

### 8B. Sinking the screw head

CCS 4.0, 5.0, 7.0

Turn the screw until the screw head is completely inserted in the bone.

Remove the K-wire.

#### Warning

The correct position of the screw, screw head and screw tip as well as the screw length always have to be verified using X-ray control.

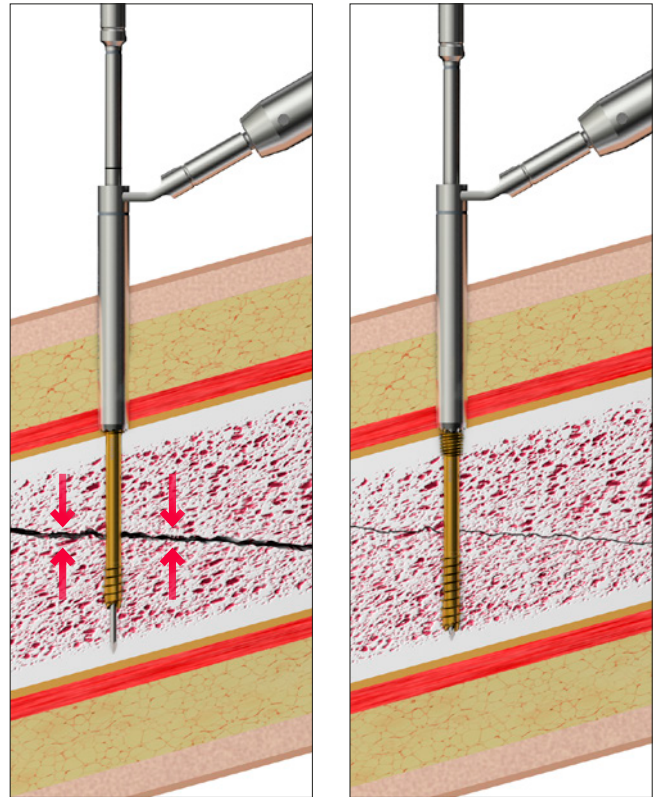

# Specific Surgical Techniques

## Click-On Parallel K-Wire Guide

### CCS 2.2, 3.0

The click-on parallel K-wire guide (A-2027) can be used to either place two screws for rotational stable treatment of a fracture or to place a second parallel K-wire for intraoperative rotational stability.

#### 1. Placing the K-wire

Place the first K-wire so that a second K-wire can be placed (see Step 3 on page 9 in General Surgical Techniques for CCS 1.7, 2.2, 3.0 and headedCCS 2.2, 3.0).



#### 2. Attaching the click-on parallel K-wire guide

Attach the click-on parallel K-wire guide (A-2027) to the side marked "K-WIRE" of the drill guide (A-2725, A-2825). Depending on the shape of the bone, the long side of the click-on guide can either be turned up or down.



**3A. Placing over the K-wire**

Place the click-on parallel K-wire guide (A-2027) over the K-wire which is already placed. The second K-wire can then be positioned through the drill guide (A-2725, A-2825).

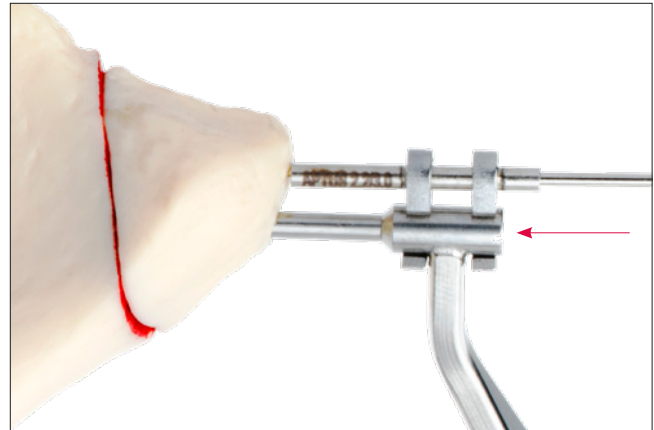
**3B. Checking the K-wire position**

Use X-ray control to verify the correct position of the K-wire.

**4. Determining the required screw length**

Continue with Step 4 on page 10 in General Surgical Techniques for CCS 1.7, 2.2, 3.0.

**Caution**

The click-on parallel K-wire guide must be removed parallel from the drill guide. If the guide is turned off, the click connection may distort.



**Drill Stop****CCS 2.2, 3.0**



The drill stop (A-2038) can be used to drill to the determined or requested drill depth.

**Caution**

The drill stop is only to be used together with the corresponding cannulated twist drills (A-3738 and A-3838).

### 1. Attaching the drill stop

Slide the drill stop (A-2038) onto the drill. The drill stop has a pictogram on both of its ends:  and .

Please make sure that  is mounted towards the scale and  towards the tip of the drill.

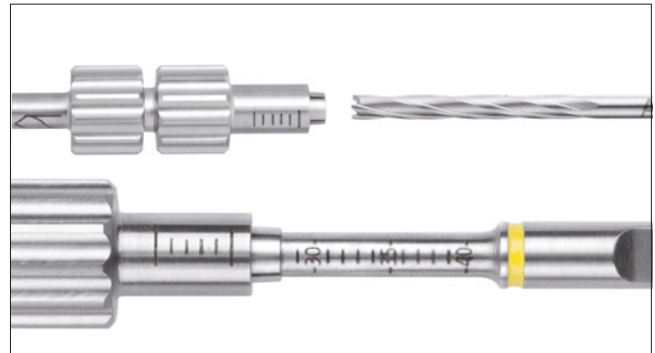

### 2. Adjusting to the drill depth

Adjust the drill stop (A-2038) to the determined or the requested drill depth and tighten it securely. The depth can be read at the end of the drill stop.

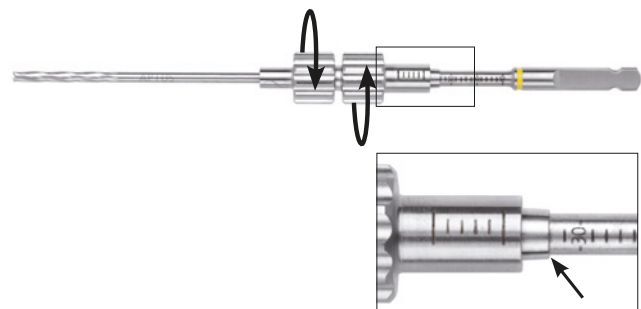

### 3. Drilling

Slide the drill guide and the drill over the K-wire and onto the bone. Use the side of the drill guide that is labeled with "DRILL".

The drill depth equals exactly the adjusted depth of the drill stop.

#### Caution

If the drill guide (A-2725, A-2825) is not used, the hole will be drilled too deep.

If excessive axial pressure is applied, the drill stop may move on the drill.

Do not drill beyond the tip of the K-wire, as the K-wire will no longer have purchase in the bone. Therefore, the drill depth should be chosen accordingly (e.g. slightly shorter).



### 4. Selecting the screw

Continue with Step 6 on page 11 in General Surgical Techniques for CCS 1.7, 2.2, 3.0 and headedCCS 2.0, 3.0.



## Protecting Soft Tissue During Screw Insertion

### CCS 2.2, 3.0

If required, the 2.2/3.0 protection sleeve (A-2039) can be used to protect the surrounding soft tissue.  
Slide the protection sleeve onto the screwdriver blade.

Put the screw onto the screwdriver.

Slide the protection sleeve to the bone.  
During screw insertion the protection sleeve slides back.

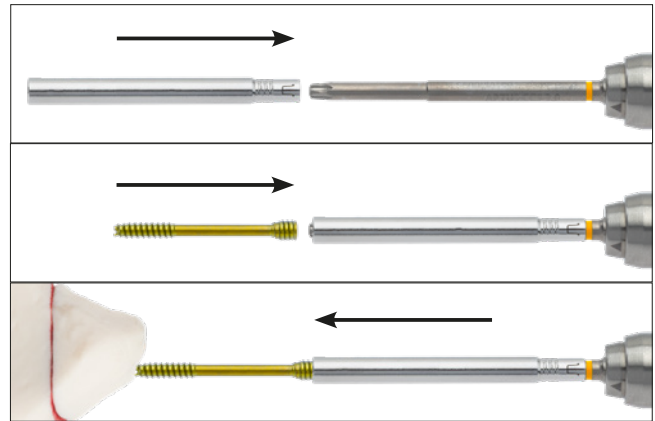

## Determining Soft Tissue Thickness

### CCS 4.0, 5.0, 7.0 and headedCCS 4.0, 5.0, 7.0

#### Caution

The depth gauge shows four laser-marked ring groups in the tip area for a rough estimate of the position relative to the soft tissue thickness when used **without** a protection sleeve.



#### Caution

The blade shows one single laser-marked ring in the shaft area for a rough orientation of the insertion depth relative to the soft tissue thickness when used **with** a protection sleeve. If the screw is completely inserted, this single ring is approximately positioned at the level of the end of the protection sleeve.

In addition, the blade – like the depth gauge (A-8004.27, A-8000.27, A-8001.27) – shows four laser-marked ring groups in the tip area for a rough orientation of the insertion depth relative to the soft tissue thickness when used **without** a protection sleeve. If the screw is inserted in the soft tissue to the previously determined depth gauge's ring group, the screw head is approximately positioned at the level of the cortex.

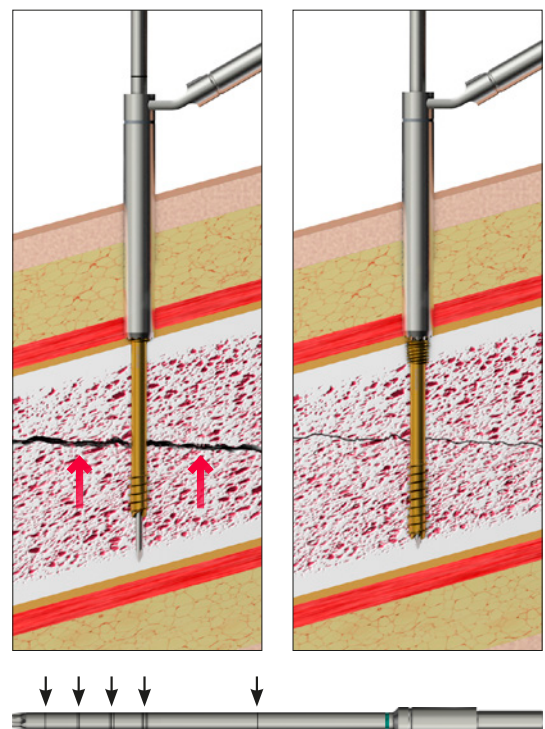

# Explantation

## **Notice**

For implant removal, it is recommended that the implants are removed by using only original APTUS instruments.

When removing implants, ensure that any bone ingrowth in the screw head has been removed.

It is recommended to insert a K-wire into the screw cannulation.

The screwdriver-screw head connection must be aligned in an axial direction. Ensure that the cannulated screwdriver blade is fully inserted into the HexaDrive recess of the screw head.



# Implants, Instruments and Containers

## CCS 1.7, Self-Drilling, HexaDrive 4

Material: Titanium alloy (ASTMF136)



Length	Head Height	Pieces / Pkg	Long Thread			Fully Threaded	
			Thread Length	Art. No.	STERILE	Art. No.	STERILE
6 mm	2.0 mm	1				A-5282.06 / 1	A-5282.06 / 1S
7 mm	2.0 mm	1				A-5282.07 / 1	A-5282.07 / 1S
8 mm	2.0 mm	1	3 mm	A-5281.08 / 1	A-5281.08 / 1S	A-5282.08 / 1	A-5282.08 / 1S
9 mm	2.0 mm	1	4 mm	A-5281.09 / 1	A-5281.09 / 1S	A-5282.09 / 1	A-5282.09 / 1S
10 mm	2.0 mm	1	4 mm	A-5281.10 / 1	A-5281.10 / 1S	A-5282.10 / 1	A-5282.10 / 1S
11 mm	2.0 mm	1	5 mm	A-5281.11 / 1	A-5281.11 / 1S	A-5282.11 / 1	A-5282.11 / 1S
12 mm	2.0 mm	1	5 mm	A-5281.12 / 1	A-5281.12 / 1S	A-5282.12 / 1	A-5282.12 / 1S
13 mm	2.0 mm	1	5 mm	A-5281.13 / 1	A-5281.13 / 1S	A-5282.13 / 1	A-5282.13 / 1S
14 mm	2.0 mm	1	6 mm	A-5281.14 / 1	A-5281.14 / 1S	A-5282.14 / 1	A-5282.14 / 1S
15 mm	2.0 mm	1	6 mm	A-5281.15 / 1	A-5281.15 / 1S	A-5282.15 / 1	A-5282.15 / 1S
16 mm	2.0 mm	1	7 mm	A-5281.16 / 1	A-5281.16 / 1S	A-5282.16 / 1	A-5282.16 / 1S
18 mm	2.0 mm	1	7 mm	A-5281.18 / 1	A-5281.18 / 1S		
20 mm	2.0 mm	1	8 mm	A-5281.20 / 1	A-5281.20 / 1S		

## CCS 2.2, Self-Drilling, HexaDrive 7

Material: Titanium alloy (ASTMF136)



Length	Head Height	Pieces / Pkg	Short Thread			Long Thread		
			Thread Length	Art. No.	STERILE	Thread Length	Art. No.	STERILE
10 mm	3.0 mm	1	4 mm	A-5780.10 / 1	A-5780.10 / 1S			
11 mm	3.0 mm	1	5 mm	A-5780.11 / 1	A-5780.11 / 1S			
12 mm	3.0 mm	1	5 mm	A-5780.12 / 1	A-5780.12 / 1S			
13 mm	3.0 mm	1	5 mm	A-5780.13 / 1	A-5780.13 / 1S			
14 mm	3.0 mm	1	5 mm	A-5780.14 / 1	A-5780.14 / 1S			
15 mm	3.0 mm	1	5 mm	A-5780.15 / 1	A-5780.15 / 1S			
16 mm	3.0 mm	1	5 mm	A-5780.16 / 1	A-5780.16 / 1S			
17 mm	3.0 mm	1	5 mm	A-5780.17 / 1	A-5780.17 / 1S			
18 mm	3.0 mm	1	5 mm	A-5780.18 / 1	A-5780.18 / 1S			
19 mm	3.0 mm	1	5 mm	A-5780.19 / 1	A-5780.19 / 1S			
20 mm	3.0 mm	1	5 mm	A-5780.20 / 1	A-5780.20 / 1S			
21 mm	3.0 mm	1	5 mm	A-5780.21 / 1	A-5780.21 / 1S			
22 mm	3.0 mm	1	5 mm	A-5780.22 / 1	A-5780.22 / 1S	8 mm	A-5781.22 / 1	A-5781.22 / 1S
23 mm	3.0 mm	1	5 mm	A-5780.23 / 1	A-5780.23 / 1S			

Length	Head Height	Pieces / Pkg	Short Thread			Long Thread		
			Thread Length	Art. No.	STERILE	Thread Length	Art. No.	STERILE
24 mm	3.0 mm	1	6 mm	A-5780.24 / 1	A-5780.24 / 1S	8 mm	A-5781.24 / 1	A-5781.24 / 1S
25 mm	3.0 mm	1	6 mm	A-5780.25 / 1	A-5780.25 / 1S			
26 mm	3.0 mm	1	6 mm	A-5780.26 / 1	A-5780.26 / 1S	8 mm	A-5781.26 / 1	A-5781.26 / 1S
27 mm	3.0 mm	1	6 mm	A-5780.27 / 1	A-5780.27 / 1S			
28 mm	3.0 mm	1	6 mm	A-5780.28 / 1	A-5780.28 / 1S	9 mm	A-5781.28 / 1	A-5781.28 / 1S
29 mm	3.0 mm	1	6 mm	A-5780.29 / 1	A-5780.29 / 1S			
30 mm	3.0 mm	1	6 mm	A-5780.30 / 1	A-5780.30 / 1S	10 mm	A-5781.30 / 1	A-5781.30 / 1S
32 mm	3.0 mm	1				11 mm	A-5781.32 / 1	A-5781.32 / 1S
34 mm	3.0 mm	1				12 mm	A-5781.34 / 1	A-5781.34 / 1S
36 mm	3.0 mm	1				13 mm	A-5781.36 / 1	A-5781.36 / 1S
38 mm	3.0 mm	1				14 mm	A-5781.38 / 1	A-5781.38 / 1S
40 mm	3.0 mm	1				15 mm	A-5781.40 / 1	A-5781.40 / 1S

### headedCCS 2.2, Self-Drilling, HexaDrive 7

Material: Titanium alloy (ASTM F136)



Length	Head Height	Pieces / Pkg	Short Thread			Long Thread		
			Thread Length	Art. No.	STERILE	Thread Length	Art. No.	STERILE
10 mm	2.1 mm	1	4 mm	A-5785.10 / 1	A-5785.10 / 1S			
11 mm	2.1 mm	1	5 mm	A-5785.11 / 1	A-5785.11 / 1S			
12 mm	2.1 mm	1	5 mm	A-5785.12 / 1	A-5785.12 / 1S			
13 mm	2.1 mm	1	5 mm	A-5785.13 / 1	A-5785.13 / 1S			
14 mm	2.1 mm	1	5 mm	A-5785.14 / 1	A-5785.14 / 1S			
15 mm	2.1 mm	1	5 mm	A-5785.15 / 1	A-5785.15 / 1S			
16 mm	2.1 mm	1	5 mm	A-5785.16 / 1	A-5785.16 / 1S			
17 mm	2.1 mm	1	5 mm	A-5785.17 / 1	A-5785.17 / 1S			
18 mm	2.1 mm	1	5 mm	A-5785.18 / 1	A-5785.18 / 1S			
19 mm	2.1 mm	1	5 mm	A-5785.19 / 1	A-5785.19 / 1S			
20 mm	2.1 mm	1	5 mm	A-5785.20 / 1	A-5785.20 / 1S	8 mm	A-5786.20 / 1	A-5786.20 / 1S
21 mm	2.1 mm	1	5 mm	A-5785.21 / 1	A-5785.21 / 1S	8 mm	A-5786.21 / 1	A-5786.21 / 1S
22 mm	2.1 mm	1	5 mm	A-5785.22 / 1	A-5785.22 / 1S	8 mm	A-5786.22 / 1	A-5786.22 / 1S
23 mm	2.1 mm	1	5 mm	A-5785.23 / 1	A-5785.23 / 1S	8 mm	A-5786.23 / 1	A-5786.23 / 1S
24 mm	2.1 mm	1	6 mm	A-5785.24 / 1	A-5785.24 / 1S	8 mm	A-5786.24 / 1	A-5786.24 / 1S
25 mm	2.1 mm	1	6 mm	A-5785.25 / 1	A-5785.25 / 1S	8 mm	A-5786.25 / 1	A-5786.25 / 1S
26 mm	2.1 mm	1	6 mm	A-5785.26 / 1	A-5785.26 / 1S	8 mm	A-5786.26 / 1	A-5786.26 / 1S
27 mm	2.1 mm	1	6 mm	A-5785.27 / 1	A-5785.27 / 1S	9 mm	A-5786.27 / 1	A-5786.27 / 1S
28 mm	2.1 mm	1	6 mm	A-5785.28 / 1	A-5785.28 / 1S	9 mm	A-5786.28 / 1	A-5786.28 / 1S
29 mm	2.1 mm	1	6 mm	A-5785.29 / 1	A-5785.29 / 1S	10 mm	A-5786.29 / 1	A-5786.29 / 1S
30 mm	2.1 mm	1	6 mm	A-5785.30 / 1	A-5785.30 / 1S	10 mm	A-5786.30 / 1	A-5786.30 / 1S
32 mm	2.1 mm	1	6 mm	A-5785.32 / 1	A-5785.32 / 1S	11 mm	A-5786.32 / 1	A-5786.32 / 1S
34 mm	2.1 mm	1	7 mm	A-5785.34 / 1	A-5785.34 / 1S	12 mm	A-5786.34 / 1	A-5786.34 / 1S
36 mm	2.1 mm	1	7 mm	A-5785.36 / 1	A-5785.36 / 1S	13 mm	A-5786.36 / 1	A-5786.36 / 1S
38 mm	2.1 mm	1	8 mm	A-5785.38 / 1	A-5785.38 / 1S	14 mm	A-5786.38 / 1	A-5786.38 / 1S
40 mm	2.1 mm	1	8 mm	A-5785.40 / 1	A-5785.40 / 1S	15 mm	A-5786.40 / 1	A-5786.40 / 1S

### CCS 3.0, Self-Drilling, HexaDrive 10

Material: Titanium alloy (ASTM F136)

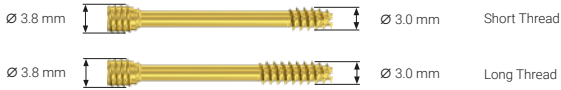

Length	Head Height	Pieces / Pkg	Short Thread			Long Thread		
			Thread Length	Art. No.	STERILE	Thread Length	Art. No.	STERILE
10 mm	4.5 mm	1	3.5 mm	A-5880.10 / 1	A-5880.10 / 1S			
11 mm	4.5 mm	1	4.5 mm	A-5880.11 / 1	A-5880.11 / 1S			
12 mm	4.5 mm	1	5 mm	A-5880.12 / 1	A-5880.12 / 1S			
13 mm	4.5 mm	1	5 mm	A-5880.13 / 1	A-5880.13 / 1S			
14 mm	4.5 mm	1	5 mm	A-5880.14 / 1	A-5880.14 / 1S			
15 mm	4.5 mm	1	5 mm	A-5880.15 / 1	A-5880.15 / 1S			
16 mm	4.5 mm	1	5 mm	A-5880.16 / 1	A-5880.16 / 1S			
17 mm	4.5 mm	1	5 mm	A-5880.17 / 1	A-5880.17 / 1S			
18 mm	4.5 mm	1	5 mm	A-5880.18 / 1	A-5880.18 / 1S			
19 mm	4.5 mm	1	5 mm	A-5880.19 / 1	A-5880.19 / 1S			
20 mm	4.5 mm	1	5 mm	A-5880.20 / 1	A-5880.20 / 1S			
21 mm	4.5 mm	1	5 mm	A-5880.21 / 1	A-5880.21 / 1S			
22 mm	4.5 mm	1	5 mm	A-5880.22 / 1	A-5880.22 / 1S			
23 mm	4.5 mm	1	5 mm	A-5880.23 / 1	A-5880.23 / 1S			
24 mm	4.5 mm	1	6 mm	A-5880.24 / 1	A-5880.24 / 1S			
25 mm	4.5 mm	1	6 mm	A-5880.25 / 1	A-5880.25 / 1S			
26 mm	4.5 mm	1	6 mm	A-5880.26 / 1	A-5880.26 / 1S	8 mm	A-5881.26 / 1	A-5881.26 / 1S
27 mm	4.5 mm	1	6 mm	A-5880.27 / 1	A-5880.27 / 1S			
28 mm	4.5 mm	1	6 mm	A-5880.28 / 1	A-5880.28 / 1S	9 mm	A-5881.28 / 1	A-5881.28 / 1S
29 mm	4.5 mm	1	6 mm	A-5880.29 / 1	A-5880.29 / 1S			
30 mm	4.5 mm	1	6 mm	A-5880.30 / 1	A-5880.30 / 1S	10 mm	A-5881.30 / 1	A-5881.30 / 1S
32 mm	4.5 mm	1	6 mm	A-5880.32 / 1	A-5880.32 / 1S	11 mm	A-5881.32 / 1	A-5881.32 / 1S
34 mm	4.5 mm	1	7 mm	A-5880.34 / 1	A-5880.34 / 1S	12 mm	A-5881.34 / 1	A-5881.34 / 1S
36 mm	4.5 mm	1	7 mm	A-5880.36 / 1	A-5880.36 / 1S	13 mm	A-5881.36 / 1	A-5881.36 / 1S
38 mm	4.5 mm	1	8 mm	A-5880.38 / 1	A-5880.38 / 1S	14 mm	A-5881.38 / 1	A-5881.38 / 1S
40 mm	4.5 mm	1	8 mm	A-5880.40 / 1	A-5880.40 / 1S	15 mm	A-5881.40 / 1	A-5881.40 / 1S

### headedCCS 3.0, Self-Drilling, HexaDrive 10

Material: Titanium alloy (ASTM F136)

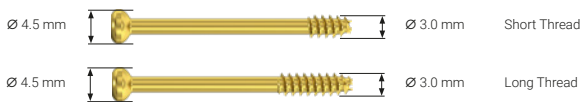

Length	Head Height	Pieces / Pkg	Short Thread			Long Thread		
			Thread Length	Art. No.	STERILE	Thread Length	Art. No.	STERILE
10 mm	2.7 mm	1	4 mm	A-5885.10 / 1	A-5885.10 / 1S			
11 mm	2.7 mm	1	5 mm	A-5885.11 / 1	A-5885.11 / 1S			
12 mm	2.7 mm	1	5 mm	A-5885.12 / 1	A-5885.12 / 1S			
13 mm	2.7 mm	1	5 mm	A-5885.13 / 1	A-5885.13 / 1S			
14 mm	2.7 mm	1	5 mm	A-5885.14 / 1	A-5885.14 / 1S			
15 mm	2.7 mm	1	5 mm	A-5885.15 / 1	A-5885.15 / 1S			
16 mm	2.7 mm	1	5 mm	A-5885.16 / 1	A-5885.16 / 1S			
17 mm	2.7 mm	1	5 mm	A-5885.17 / 1	A-5885.17 / 1S			
18 mm	2.7 mm	1	5 mm	A-5885.18 / 1	A-5885.18 / 1S			
19 mm	2.7 mm	1	5 mm	A-5885.19 / 1	A-5885.19 / 1S			
20 mm	2.7 mm	1	5 mm	A-5885.20 / 1	A-5885.20 / 1S	8 mm	A-5886.20 / 1	A-5886.20 / 1S
21 mm	2.7 mm	1	5 mm	A-5885.21 / 1	A-5885.21 / 1S	8 mm	A-5886.21 / 1	A-5886.21 / 1S

Length	Head Height	Pieces / Pkg	Short Thread			Long Thread		
			Thread Length	Art. No.	STERILE	Thread Length	Art. No.	STERILE
22 mm	2.7 mm	1	5 mm	A-5885.22 / 1	A-5885.22 / 1S	8 mm	A-5886.22 / 1	A-5886.22 / 1S
23 mm	2.7 mm	1	5 mm	A-5885.23 / 1	A-5885.23 / 1S	8 mm	A-5886.23 / 1	A-5886.23 / 1S
24 mm	2.7 mm	1	6 mm	A-5885.24 / 1	A-5885.24 / 1S	8 mm	A-5886.24 / 1	A-5886.24 / 1S
25 mm	2.7 mm	1	6 mm	A-5885.25 / 1	A-5885.25 / 1S	8 mm	A-5886.25 / 1	A-5886.25 / 1S
26 mm	2.7 mm	1	6 mm	A-5885.26 / 1	A-5885.26 / 1S	8 mm	A-5886.26 / 1	A-5886.26 / 1S
27 mm	2.7 mm	1	6 mm	A-5885.27 / 1	A-5885.27 / 1S	9 mm	A-5886.27 / 1	A-5886.27 / 1S
28 mm	2.7 mm	1	6 mm	A-5885.28 / 1	A-5885.28 / 1S	9 mm	A-5886.28 / 1	A-5886.28 / 1S
29 mm	2.7 mm	1	6 mm	A-5885.29 / 1	A-5885.29 / 1S	10 mm	A-5886.29 / 1	A-5886.29 / 1S
30 mm	2.7 mm	1	6 mm	A-5885.30 / 1	A-5885.30 / 1S	10 mm	A-5886.30 / 1	A-5886.30 / 1S
32 mm	2.7 mm	1	6 mm	A-5885.32 / 1	A-5885.32 / 1S	11 mm	A-5886.32 / 1	A-5886.32 / 1S
34 mm	2.7 mm	1	7 mm	A-5885.34 / 1	A-5885.34 / 1S	12 mm	A-5886.34 / 1	A-5886.34 / 1S
36 mm	2.7 mm	1	7 mm	A-5885.36 / 1	A-5885.36 / 1S	13 mm	A-5886.36 / 1	A-5886.36 / 1S
38 mm	2.7 mm	1	8 mm	A-5885.38 / 1	A-5885.38 / 1S	14 mm	A-5886.38 / 1	A-5886.38 / 1S
40 mm	2.7 mm	1	8 mm	A-5885.40 / 1	A-5885.40 / 1S	15 mm	A-5886.40 / 1	A-5886.40 / 1S

### CCS 4.0, Self-Drilling, HexaDrive 12

Material: Titanium alloy (ASTM F136)

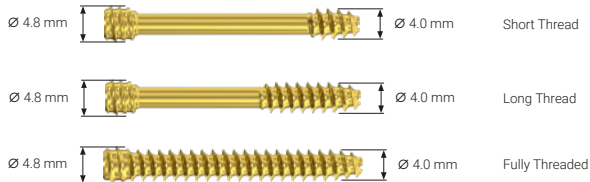

Length	Head Height	Pieces / Pkg	Short Thread			Long Thread			Fully Threaded	
			Thread Length	Art. No.	STERILE	Thread Length	Art. No.	STERILE	Art. No.	STERILE
16 mm	4.5 mm	1	4 mm	A-8110.16 / 1	A-8110.16 / 1S				A-8112.16 / 1	A-8112.16 / 1S
18 mm	4.5 mm	1	4 mm	A-8110.18 / 1	A-8110.18 / 1S				A-8112.18 / 1	A-8112.18 / 1S
20 mm	4.5 mm	1	4 mm	A-8110.20 / 1	A-8110.20 / 1S	8 mm	A-8111.20 / 1	A-8111.20 / 1S	A-8112.20 / 1	A-8112.20 / 1S
22 mm	4.5 mm	1	5 mm	A-8110.22 / 1	A-8110.22 / 1S	9 mm	A-8111.22 / 1	A-8111.22 / 1S	A-8112.22 / 1	A-8112.22 / 1S
24 mm	4.5 mm	1	5 mm	A-8110.24 / 1	A-8110.24 / 1S	10 mm	A-8111.24 / 1	A-8111.24 / 1S	A-8112.24 / 1	A-8112.24 / 1S
26 mm	4.5 mm	1	5 mm	A-8110.26 / 1	A-8110.26 / 1S	11 mm	A-8111.26 / 1	A-8111.26 / 1S	A-8112.26 / 1	A-8112.26 / 1S
28 mm	4.5 mm	1	6 mm	A-8110.28 / 1	A-8110.28 / 1S	11 mm	A-8111.28 / 1	A-8111.28 / 1S	A-8112.28 / 1	A-8112.28 / 1S
30 mm	4.5 mm	1	6 mm	A-8110.30 / 1	A-8110.30 / 1S	12 mm	A-8111.30 / 1	A-8111.30 / 1S	A-8112.30 / 1	A-8112.30 / 1S
32 mm	4.5 mm	1	7 mm	A-8110.32 / 1	A-8110.32 / 1S	13 mm	A-8111.32 / 1	A-8111.32 / 1S	A-8112.32 / 1	A-8112.32 / 1S
34 mm	4.5 mm	1	7 mm	A-8110.34 / 1	A-8110.34 / 1S	14 mm	A-8111.34 / 1	A-8111.34 / 1S	A-8112.34 / 1	A-8112.34 / 1S
36 mm	4.5 mm	1	8 mm	A-8110.36 / 1	A-8110.36 / 1S	14 mm	A-8111.36 / 1	A-8111.36 / 1S	A-8112.36 / 1	A-8112.36 / 1S
38 mm	4.5 mm	1	8 mm	A-8110.38 / 1	A-8110.38 / 1S	15 mm	A-8111.38 / 1	A-8111.38 / 1S	A-8112.38 / 1	A-8112.38 / 1S
40 mm	4.5 mm	1	8 mm	A-8110.40 / 1	A-8110.40 / 1S	16 mm	A-8111.40 / 1	A-8111.40 / 1S	A-8112.40 / 1	A-8112.40 / 1S
42 mm	4.5 mm	1	9 mm	A-8110.42 / 1	A-8110.42 / 1S	17 mm	A-8111.42 / 1	A-8111.42 / 1S	A-8112.42 / 1	A-8112.42 / 1S
44 mm	4.5 mm	1	9 mm	A-8110.44 / 1	A-8110.44 / 1S	18 mm	A-8111.44 / 1	A-8111.44 / 1S	A-8112.44 / 1	A-8112.44 / 1S
46 mm	4.5 mm	1	9 mm	A-8110.46 / 1	A-8110.46 / 1S	19 mm	A-8111.46 / 1	A-8111.46 / 1S	A-8112.46 / 1	A-8112.46 / 1S
48 mm	4.5 mm	1	10 mm	A-8110.48 / 1	A-8110.48 / 1S	19 mm	A-8111.48 / 1	A-8111.48 / 1S	A-8112.48 / 1	A-8112.48 / 1S
50 mm	4.5 mm	1	10 mm	A-8110.50 / 1	A-8110.50 / 1S	20 mm	A-8111.50 / 1	A-8111.50 / 1S	A-8112.50 / 1	A-8112.50 / 1S
55 mm	4.5 mm	1	11 mm	A-8110.55 / 1	A-8110.55 / 1S	22 mm	A-8111.55 / 1	A-8111.55 / 1S	A-8112.55 / 1	A-8112.55 / 1S
60 mm	4.5 mm	1	12 mm	A-8110.60 / 1	A-8110.60 / 1S	24 mm	A-8111.60 / 1	A-8111.60 / 1S	A-8112.60 / 1	A-8112.60 / 1S

## headed CCS 4.0, Self-Drilling, HexaDrive 12

Material: Titanium alloy (ASTM F136)

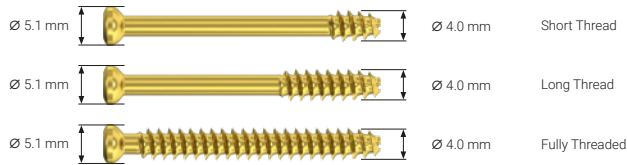

Length	Head Height	Pieces / Pkg	Short Thread			Long Thread			Fully Threaded	
			Thread Length	Art. No.	STERILE	Thread Length	Art. No.	STERILE	Art. No.	STERILE
16 mm	2.8 mm	1	4 mm	A-8115.16 / 1	A-8115.16 / 1S				A-8117.16 / 1	A-8117.16 / 1S
18 mm	2.8 mm	1	4 mm	A-8115.18 / 1	A-8115.18 / 1S				A-8117.18 / 1	A-8117.18 / 1S
20 mm	2.8 mm	1	4 mm	A-8115.20 / 1	A-8115.20 / 1S	8 mm	A-8116.20 / 1	A-8116.20 / 1S	A-8117.20 / 1	A-8117.20 / 1S
22 mm	2.8 mm	1	5 mm	A-8115.22 / 1	A-8115.22 / 1S	9 mm	A-8116.22 / 1	A-8116.22 / 1S	A-8117.22 / 1	A-8117.22 / 1S
24 mm	2.8 mm	1	5 mm	A-8115.24 / 1	A-8115.24 / 1S	10 mm	A-8116.24 / 1	A-8116.24 / 1S	A-8117.24 / 1	A-8117.24 / 1S
26 mm	2.8 mm	1	5 mm	A-8115.26 / 1	A-8115.26 / 1S	11 mm	A-8116.26 / 1	A-8116.26 / 1S	A-8117.26 / 1	A-8117.26 / 1S
28 mm	2.8 mm	1	6 mm	A-8115.28 / 1	A-8115.28 / 1S	11 mm	A-8116.28 / 1	A-8116.28 / 1S	A-8117.28 / 1	A-8117.28 / 1S
30 mm	2.8 mm	1	6 mm	A-8115.30 / 1	A-8115.30 / 1S	12 mm	A-8116.30 / 1	A-8116.30 / 1S	A-8117.30 / 1	A-8117.30 / 1S
32 mm	2.8 mm	1	7 mm	A-8115.32 / 1	A-8115.32 / 1S	13 mm	A-8116.32 / 1	A-8116.32 / 1S	A-8117.32 / 1	A-8117.32 / 1S
34 mm	2.8 mm	1	7 mm	A-8115.34 / 1	A-8115.34 / 1S	14 mm	A-8116.34 / 1	A-8116.34 / 1S	A-8117.34 / 1	A-8117.34 / 1S
36 mm	2.8 mm	1	7 mm	A-8115.36 / 1	A-8115.36 / 1S	14 mm	A-8116.36 / 1	A-8116.36 / 1S	A-8117.36 / 1	A-8117.36 / 1S
38 mm	2.8 mm	1	8 mm	A-8115.38 / 1	A-8115.38 / 1S	15 mm	A-8116.38 / 1	A-8116.38 / 1S	A-8117.38 / 1	A-8117.38 / 1S
40 mm	2.8 mm	1	8 mm	A-8115.40 / 1	A-8115.40 / 1S	16 mm	A-8116.40 / 1	A-8116.40 / 1S	A-8117.40 / 1	A-8117.40 / 1S
42 mm	2.8 mm	1	9 mm	A-8115.42 / 1	A-8115.42 / 1S	17 mm	A-8116.42 / 1	A-8116.42 / 1S	A-8117.42 / 1	A-8117.42 / 1S
44 mm	2.8 mm	1	9 mm	A-8115.44 / 1	A-8115.44 / 1S	18 mm	A-8116.44 / 1	A-8116.44 / 1S	A-8117.44 / 1	A-8117.44 / 1S
46 mm	2.8 mm	1	9 mm	A-8115.46 / 1	A-8115.46 / 1S	19 mm	A-8116.46 / 1	A-8116.46 / 1S	A-8117.46 / 1	A-8117.46 / 1S
48 mm	2.8 mm	1	10 mm	A-8115.48 / 1	A-8115.48 / 1S	19 mm	A-8116.48 / 1	A-8116.48 / 1S	A-8117.48 / 1	A-8117.48 / 1S
50 mm	2.8 mm	1	10 mm	A-8115.50 / 1	A-8115.50 / 1S	20 mm	A-8116.50 / 1	A-8116.50 / 1S	A-8117.50 / 1	A-8117.50 / 1S
55 mm	2.8 mm	1	11 mm	A-8115.55 / 1	A-8115.55 / 1S	22 mm	A-8116.55 / 1	A-8116.55 / 1S	A-8117.55 / 1	A-8117.55 / 1S
60 mm	2.8 mm	1	12 mm	A-8115.60 / 1	A-8115.60 / 1S	24 mm	A-8116.60 / 1	A-8116.60 / 1S	A-8117.60 / 1	A-8117.60 / 1S

## CCS 5.0, Self-Drilling, HexaDrive 15

Material: Titanium alloy (ASTM F136)

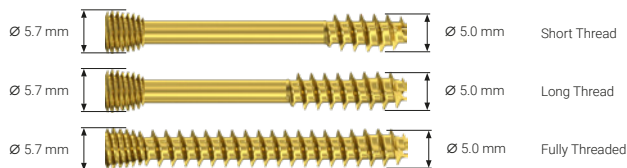

Length	Head Height	Pieces / Pkg	Short Thread			Long Thread			Fully Threaded	
			Thread Length	Art. No.	STERILE	Thread Length	Art. No.	STERILE	Art. No.	STERILE
24 mm	5.2 mm	1	9 mm	A-8210.24 / 1	A-8210.24 / 1S				A-8212.24 / 1	A-8212.24 / 1S
26 mm	5.2 mm	1	9 mm	A-8210.26 / 1	A-8210.26 / 1S				A-8212.26 / 1	A-8212.26 / 1S
28 mm	5.2 mm	1	9 mm	A-8210.28 / 1	A-8210.28 / 1S				A-8212.28 / 1	A-8212.28 / 1S
30 mm	5.2 mm	1	9 mm	A-8210.30 / 1	A-8210.30 / 1S	12 mm	A-8211.30 / 1	A-8211.30 / 1S	A-8212.30 / 1	A-8212.30 / 1S
32 mm	5.2 mm	1	9 mm	A-8210.32 / 1	A-8210.32 / 1S	13 mm	A-8211.32 / 1	A-8211.32 / 1S	A-8212.32 / 1	A-8212.32 / 1S
34 mm	5.2 mm	1	9 mm	A-8210.34 / 1	A-8210.34 / 1S	14 mm	A-8211.34 / 1	A-8211.34 / 1S	A-8212.34 / 1	A-8212.34 / 1S
36 mm	5.2 mm	1	10 mm	A-8210.36 / 1	A-8210.36 / 1S	14 mm	A-8211.36 / 1	A-8211.36 / 1S	A-8212.36 / 1	A-8212.36 / 1S
38 mm	5.2 mm	1	10 mm	A-8210.38 / 1	A-8210.38 / 1S	15 mm	A-8211.38 / 1	A-8211.38 / 1S	A-8212.38 / 1	A-8212.38 / 1S
40 mm	5.2 mm	1	11 mm	A-8210.40 / 1	A-8210.40 / 1S	16 mm	A-8211.40 / 1	A-8211.40 / 1S	A-8212.40 / 1	A-8212.40 / 1S
45 mm	5.2 mm	1	11 mm	A-8210.45 / 1	A-8210.45 / 1S	18 mm	A-8211.45 / 1	A-8211.45 / 1S	A-8212.45 / 1	A-8212.45 / 1S
50 mm	5.2 mm	1	12 mm	A-8210.50 / 1	A-8210.50 / 1S	20 mm	A-8211.50 / 1	A-8211.50 / 1S	A-8212.50 / 1	A-8212.50 / 1S
55 mm	5.2 mm	1	12 mm	A-8210.55 / 1	A-8210.55 / 1S	22 mm	A-8211.55 / 1	A-8211.55 / 1S	A-8212.55 / 1	A-8212.55 / 1S
60 mm	5.2 mm	1	13 mm	A-8210.60 / 1	A-8210.60 / 1S	24 mm	A-8211.60 / 1	A-8211.60 / 1S	A-8212.60 / 1	A-8212.60 / 1S
65 mm	5.2 mm	1	13 mm	A-8210.65 / 1	A-8210.65 / 1S	26 mm	A-8211.65 / 1	A-8211.65 / 1S	A-8212.65 / 1	A-8212.65 / 1S
70 mm	5.2 mm	1	14 mm	A-8210.70 / 1	A-8210.70 / 1S	28 mm	A-8211.70 / 1	A-8211.70 / 1S	A-8212.70 / 1	A-8212.70 / 1S

## headedCCS 5.0, Self-Drilling, HexaDrive 15

Material: Titanium alloy (ASTM F136)

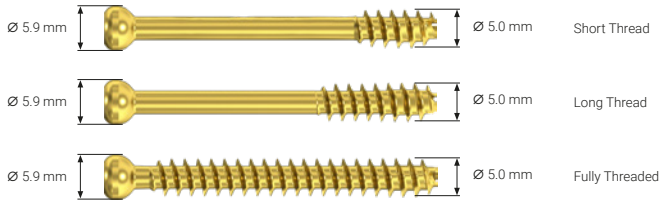

Length	Head Height	Pieces / Pkg	Short Thread			Long Thread			Fully Threaded	
			Thread Length	Art. No.	STERILE	Thread Length	Art. No.	STERILE	Art. No.	STERILE
24 mm	4.2 mm	1	9 mm	A-8215.24 / 1	A-8215.24 / 1S				A-8217.24 / 1	A-8217.24 / 1S
26 mm	4.2 mm	1	9 mm	A-8215.26 / 1	A-8215.26 / 1S				A-8217.26 / 1	A-8217.26 / 1S
28 mm	4.2 mm	1	9 mm	A-8215.28 / 1	A-8215.28 / 1S				A-8217.28 / 1	A-8217.28 / 1S
30 mm	4.2 mm	1	9 mm	A-8215.30 / 1	A-8215.30 / 1S	12 mm	A-8216.30 / 1	A-8216.30 / 1S	A-8217.30 / 1	A-8217.30 / 1S
32 mm	4.2 mm	1	9 mm	A-8215.32 / 1	A-8215.32 / 1S	13 mm	A-8216.32 / 1	A-8216.32 / 1S	A-8217.32 / 1	A-8217.32 / 1S
34 mm	4.2 mm	1	9 mm	A-8215.34 / 1	A-8215.34 / 1S	14 mm	A-8216.34 / 1	A-8216.34 / 1S	A-8217.34 / 1	A-8217.34 / 1S
36 mm	4.2 mm	1	10 mm	A-8215.36 / 1	A-8215.36 / 1S	14 mm	A-8216.36 / 1	A-8216.36 / 1S	A-8217.36 / 1	A-8217.36 / 1S
38 mm	4.2 mm	1	10 mm	A-8215.38 / 1	A-8215.38 / 1S	15 mm	A-8216.38 / 1	A-8216.38 / 1S	A-8217.38 / 1	A-8217.38 / 1S
40 mm	4.2 mm	1	11 mm	A-8215.40 / 1	A-8215.40 / 1S	16 mm	A-8216.40 / 1	A-8216.40 / 1S	A-8217.40 / 1	A-8217.40 / 1S
45 mm	4.2 mm	1	11 mm	A-8215.45 / 1	A-8215.45 / 1S	18 mm	A-8216.45 / 1	A-8216.45 / 1S	A-8217.45 / 1	A-8217.45 / 1S
50 mm	4.2 mm	1	12 mm	A-8215.50 / 1	A-8215.50 / 1S	20 mm	A-8216.50 / 1	A-8216.50 / 1S	A-8217.50 / 1	A-8217.50 / 1S
55 mm	4.2 mm	1	12 mm	A-8215.55 / 1	A-8215.55 / 1S	22 mm	A-8216.55 / 1	A-8216.55 / 1S	A-8217.55 / 1	A-8217.55 / 1S
60 mm	4.2 mm	1	13 mm	A-8215.60 / 1	A-8215.60 / 1S	24 mm	A-8216.60 / 1	A-8216.60 / 1S	A-8217.60 / 1	A-8217.60 / 1S
65 mm	4.2 mm	1	13 mm	A-8215.65 / 1	A-8215.65 / 1S	26 mm	A-8216.65 / 1	A-8216.65 / 1S	A-8217.65 / 1	A-8217.65 / 1S
70 mm	4.2 mm	1	14 mm	A-8215.70 / 1	A-8215.70 / 1S	28 mm	A-8216.70 / 1	A-8216.70 / 1S	A-8217.70 / 1	A-8217.70 / 1S

## CCS 7.0, Self-Drilling, HexaDrive 25

Material: Titanium alloy (ASTM F136)

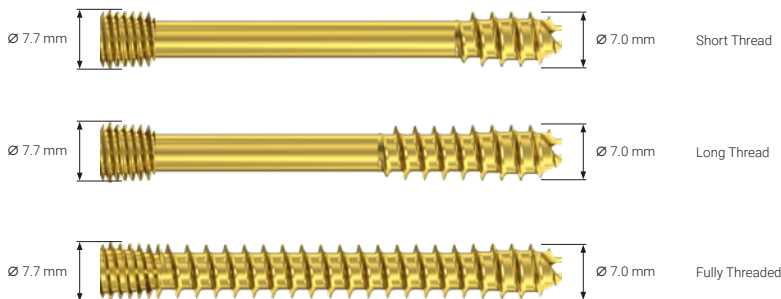

Length	Head Height	Pieces / Pkg	Short Thread			Long Thread			Fully Threaded	
			Thread Length	Art. No.	STERILE	Thread Length	Art. No.	STERILE	Art. No.	STERILE
30 mm	7.2 mm	1	12 mm		A-8410.30 / 1S				A-8412.30 / 1S	
35 mm	7.2 mm	1	12 mm		A-8410.35 / 1S	14 mm		A-8411.35 / 1S	A-8412.35 / 1S	
40 mm	7.2 mm	1	12 mm	A-8410.40 / 1	A-8410.40 / 1S	16 mm	A-8411.40 / 1	A-8411.40 / 1S	A-8412.40 / 1	A-8412.40 / 1S
45 mm	7.2 mm	1	12 mm	A-8410.45 / 1	A-8410.45 / 1S	18 mm	A-8411.45 / 1	A-8411.45 / 1S	A-8412.45 / 1	A-8412.45 / 1S
50 mm	7.2 mm	1	13 mm	A-8410.50 / 1	A-8410.50 / 1S	20 mm	A-8411.50 / 1	A-8411.50 / 1S	A-8412.50 / 1	A-8412.50 / 1S
55 mm	7.2 mm	1	13 mm	A-8410.55 / 1	A-8410.55 / 1S	22 mm	A-8411.55 / 1	A-8411.55 / 1S	A-8412.55 / 1	A-8412.55 / 1S
60 mm	7.2 mm	1	14 mm	A-8410.60 / 1	A-8410.60 / 1S	24 mm	A-8411.60 / 1	A-8411.60 / 1S	A-8412.60 / 1	A-8412.60 / 1S
65 mm	7.2 mm	1	14 mm	A-8410.65 / 1	A-8410.65 / 1S	26 mm	A-8411.65 / 1	A-8411.65 / 1S	A-8412.65 / 1	A-8412.65 / 1S
70 mm	7.2 mm	1	15 mm	A-8410.70 / 1	A-8410.70 / 1S	28 mm	A-8411.70 / 1	A-8411.70 / 1S	A-8412.70 / 1	A-8412.70 / 1S
75 mm	7.2 mm	1	15 mm	A-8410.75 / 1	A-8410.75 / 1S	30 mm	A-8411.75 / 1	A-8411.75 / 1S	A-8412.75 / 1	A-8412.75 / 1S
80 mm	7.2 mm	1	16 mm	A-8410.80 / 1	A-8410.80 / 1S	32 mm	A-8411.80 / 1	A-8411.80 / 1S	A-8412.80 / 1	A-8412.80 / 1S

Length	Head Height	Pieces / Pkg	Short Thread			Long Thread			Fully Threaded	
			Thread Length	Art. No.	STERILE	Thread Length	Art. No.	STERILE	Art. No.	STERILE
85 mm	7.2 mm	1	17 mm	A-8410.85 / 1	A-8410.85 / 1S	34 mm	A-8411.85 / 1	A-8411.85 / 1S	A-8412.85 / 1	A-8412.85 / 1S
90 mm	7.2 mm	1	18 mm	A-8410.90 / 1	A-8410.90 / 1S	36 mm	A-8411.90 / 1	A-8411.90 / 1S	A-8412.90 / 1	A-8412.90 / 1S
95 mm	7.2 mm	1	19 mm	A-8410.95 / 1	A-8410.95 / 1S	38 mm	A-8411.95 / 1	A-8411.95 / 1S	A-8412.95 / 1	A-8412.95 / 1S
100 mm	7.2 mm	1	20 mm	A-8410.100 / 1	A-8410.100 / 1S	40 mm	A-8411.100 / 1	A-8411.100 / 1S	A-8412.100 / 1	A-8412.100 / 1S
105 mm	7.2 mm	1	21 mm	A-8410.105 / 1	A-8410.105 / 1S	42 mm	A-8411.105 / 1	A-8411.105 / 1S	A-8412.105 / 1	A-8412.105 / 1S
110 mm	7.2 mm	1	22 mm	A-8410.110 / 1	A-8410.110 / 1S	44 mm	A-8411.110 / 1	A-8411.110 / 1S	A-8412.110 / 1	A-8412.110 / 1S
120 mm	7.2 mm	1	24 mm	A-8410.120 / 1	A-8410.120 / 1S	48 mm	A-8411.120 / 1	A-8411.120 / 1S	A-8412.120 / 1	A-8412.120 / 1S
130 mm	7.2 mm	1	26 mm	A-8410.130 / 1	A-8410.130 / 1S	52 mm	A-8411.130 / 1	A-8411.130 / 1S	A-8412.130 / 1	A-8412.130 / 1S
140 mm	7.2 mm	1	28 mm	A-8410.140 / 1	A-8410.140 / 1S	56 mm	A-8411.140 / 1	A-8411.140 / 1S	A-8412.140 / 1	A-8412.140 / 1S

### headed CCS 7.0, Self-Drilling, HexaDrive 25

Material: Titanium alloy (ASTM F136)

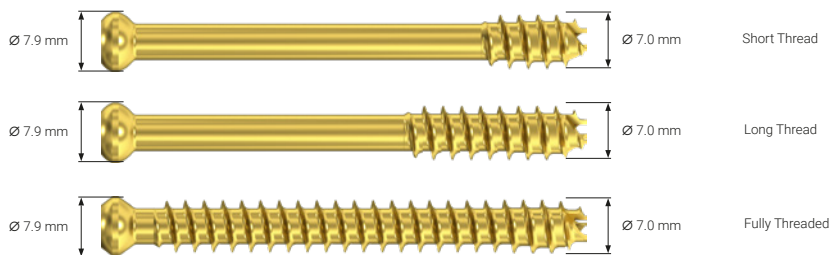

Length	Head Height	Pieces / Pkg	Short Thread			Long Thread			Fully Threaded	
			Thread Length	Art. No.	STERILE	Thread Length	Art. No.	STERILE	Art. No.	STERILE
30 mm	4.7 mm	1	12 mm	A-8415.30 / 1	A-8415.30 / 1S				A-8417.30 / 1	A-8417.30 / 1S
35 mm	4.7 mm	1	12 mm	A-8415.35 / 1	A-8415.35 / 1S	14 mm	A-8416.35 / 1	A-8416.35 / 1S	A-8417.35 / 1	A-8417.35 / 1S
40 mm	4.7 mm	1	12 mm	A-8415.40 / 1	A-8415.40 / 1S	16 mm	A-8416.40 / 1	A-8416.40 / 1S	A-8417.40 / 1	A-8417.40 / 1S
45 mm	4.7 mm	1	12 mm	A-8415.45 / 1	A-8415.45 / 1S	18 mm	A-8416.45 / 1	A-8416.45 / 1S	A-8417.45 / 1	A-8417.45 / 1S
50 mm	4.7 mm	1	13 mm	A-8415.50 / 1	A-8415.50 / 1S	20 mm	A-8416.50 / 1	A-8416.50 / 1S	A-8417.50 / 1	A-8417.50 / 1S
55 mm	4.7 mm	1	13 mm	A-8415.55 / 1	A-8415.55 / 1S	22 mm	A-8416.55 / 1	A-8416.55 / 1S	A-8417.55 / 1	A-8417.55 / 1S
60 mm	4.7 mm	1	14 mm	A-8415.60 / 1	A-8415.60 / 1S	24 mm	A-8416.60 / 1	A-8416.60 / 1S	A-8417.60 / 1	A-8417.60 / 1S
65 mm	4.7 mm	1	14 mm	A-8415.65 / 1	A-8415.65 / 1S	26 mm	A-8416.65 / 1	A-8416.65 / 1S	A-8417.65 / 1	A-8417.65 / 1S
70 mm	4.7 mm	1	15 mm	A-8415.70 / 1	A-8415.70 / 1S	28 mm	A-8416.70 / 1	A-8416.70 / 1S	A-8417.70 / 1	A-8417.70 / 1S
75 mm	4.7 mm	1	15 mm	A-8415.75 / 1	A-8415.75 / 1S	30 mm	A-8416.75 / 1	A-8416.75 / 1S	A-8417.75 / 1	A-8417.75 / 1S
80 mm	4.7 mm	1	16 mm	A-8415.80 / 1	A-8415.80 / 1S	32 mm	A-8416.80 / 1	A-8416.80 / 1S	A-8417.80 / 1	A-8417.80 / 1S
85 mm	4.7 mm	1	17 mm	A-8415.85 / 1	A-8415.85 / 1S	34 mm	A-8416.85 / 1	A-8416.85 / 1S	A-8417.85 / 1	A-8417.85 / 1S
90 mm	4.7 mm	1	18 mm	A-8415.90 / 1	A-8415.90 / 1S	36 mm	A-8416.90 / 1	A-8416.90 / 1S	A-8417.90 / 1	A-8417.90 / 1S
95 mm	4.7 mm	1	19 mm	A-8415.95 / 1	A-8415.95 / 1S	38 mm	A-8416.95 / 1	A-8416.95 / 1S	A-8417.95 / 1	A-8417.95 / 1S
100 mm	4.7 mm	1	20 mm	A-8415.100 / 1	A-8415.100 / 1S	40 mm	A-8416.100 / 1	A-8416.100 / 1S	A-8417.100 / 1	A-8417.100 / 1S
105 mm	4.7 mm	1	21 mm	A-8415.105 / 1	A-8415.105 / 1S	42 mm	A-8416.105 / 1	A-8416.105 / 1S	A-8417.105 / 1	A-8417.105 / 1S
110 mm	4.7 mm	1	22 mm	A-8415.110 / 1	A-8415.110 / 1S	44 mm	A-8416.110 / 1	A-8416.110 / 1S	A-8417.110 / 1	A-8417.110 / 1S
120 mm	4.7 mm	1	24 mm	A-8415.120 / 1	A-8415.120 / 1S	48 mm	A-8416.120 / 1	A-8416.120 / 1S	A-8417.120 / 1	A-8417.120 / 1S
130 mm	4.7 mm	1	26 mm	A-8415.130 / 1	A-8415.130 / 1S	52 mm	A-8416.130 / 1	A-8416.130 / 1S	A-8417.130 / 1	A-8417.130 / 1S
140 mm	4.7 mm	1	28 mm	A-8415.140 / 1	A-8415.140 / 1S	56 mm	A-8416.140 / 1	A-8416.140 / 1S	A-8417.140 / 1	A-8417.140 / 1S

## Washers

Material: Titanium alloy (ASTM F136)



Art. No.	STERILE	System Size	Ø	Description	Pieces / Pkg
A-4700.71 / 1	A-4700.71 / 1S	2.2	5.0 mm	for headed CCS	1
A-4800.70 / 1	A-4800.70 / 1S	3.0	6.5 mm	for headed CCS	1
A-8140.70 / 1	A-8140.70 / 1S	4.0	7.5 mm	for headed CCS	1
A-8240.70 / 1	A-8240.70 / 1S	5.0	9.0 mm	for headed CCS	1
A-8440.70 / 1	A-8440.70 / 1S	7.0	13.0 mm	for headed CCS	1

## Twist Drills, Cannulated

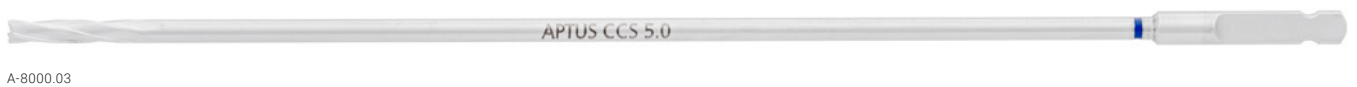

Art. No.	STERILE	System Size	Ø	Length	Description	Shaft End	Pieces /Pkg
A-3236	A-3236S	1.7	1.3 mm	67 mm	for K-wire Ø 0.6 mm	AO Quick Coupling	1
A-3736	A-3736S	2.2	1.8 mm	87 mm	for K-wire Ø 0.8 mm	AO Quick Coupling	1
A-3738	A-3738S	2.2	1.8 mm	122 mm	for K-wire Ø 0.8 mm, for drill stop A-2038	AO Quick Coupling	1
A-3836	A-3836S	3.0	2.1 mm	87 mm	for K-wire Ø 1.1 mm	AO Quick Coupling	1
A-3838	A-3838S	3.0	2.1 mm	122 mm	for K-wire Ø 1.1 mm, for drill stop A-2038	AO Quick Coupling	1
A-8000.03	A-8000.03S	5.0	3.1 mm	177 mm	for K-wire Ø 1.6 mm	AO Quick Coupling	1
A-8001.01	A-8001.01S	7.0	4.8 mm	265 mm	for K-wire Ø 2.2 mm	AO Large Quick Coupling	1
A-8004.01	A-8004.01S	4.0	2.7 mm	160 mm	for K-wire Ø 1.25 mm	AO Quick Coupling	1



## Drill Stop



Art. No.	System Size	Length	Description	Pieces / Pkg
A-2038	2.2 / 3.0	35 mm	for cannulated twist drills A-3738 and A-3838	1

## Countersinks, Cannulated



A-3932



A-3937



A-3938



A-3935



A-3936



A-8004.02

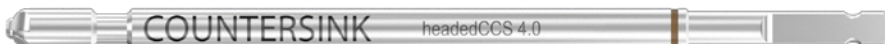

A-8004.03



A-8000.04



A-8000.05



A-8001.02



A-8001.03

Art. No.	<b>STERILE</b>	System Size	Length	Description	Shaft End	Pieces / Pkg
A-3932	A-3932S	1.7	50 mm	for CCS only	AO Quick Coupling	1
A-3935	A-3935S	2.2	68 mm	for headedCCS only	AO Quick Coupling	1
A-3936	A-3936S	3.0	68 mm	for headedCCS only	AO Quick Coupling	1
A-3937	A-3937S	2.2	68 mm	for CCS only	AO Quick Coupling	1
A-3938	A-3938S	3.0	68 mm	for CCS only	AO Quick Coupling	1
A-8000.04	A-8000.04S	5.0	117 mm	for CCS only	AO Quick Coupling	1
A-8000.05	A-8000.05S	5.0	117 mm	for headedCCS only	AO Quick Coupling	1
A-8001.02	A-8001.02S	7.0	135 mm	for CCS only	AO Large Quick Coupling	1
A-8001.03	A-8001.03S	7.0	135 mm	for headedCCS only	AO Large Quick Coupling	1
A-8004.02	A-8004.02S	4.0	117 mm	for CCS only	AO Quick Coupling	1
A-8004.03	A-8004.03S	4.0	117 mm	for headedCCS only	AO Quick Coupling	1

## K-Wires, Stainless Steel

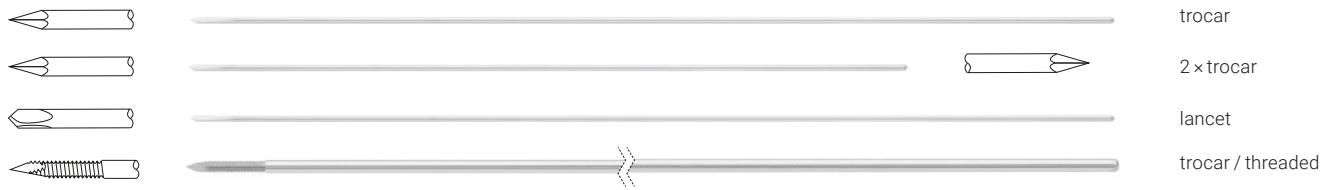

Art. No.	STERILE	System Size	Ø	Description	Length	Thread Length	Pieces / Pkg
A-5040.00		2.2	0.8 mm	trocar	100 mm		10
	A-5040.00 / 1S	2.2	0.8 mm	trocar	100 mm		1
A-5040.10		3.0	1.1 mm	trocar	100 mm		10
	A-5040.10 / 1S	3.0	1.1 mm	trocar	100 mm		1
A-5040.30		4.0	1.25 mm	trocar	200 mm		10
A-5040.30 / 1	A-5040.30 / 1S	4.0	1.25 mm	trocar	200 mm		1
A-5040.42		5.0	1.6 mm	trocar	200 mm		10
	A-5040.42 / 1S	5.0	1.6 mm	trocar	200 mm		1
A-5040.74		7.0	2.2 mm	trocar	250 mm		10
	A-5040.74 / 1S	7.0	2.2 mm	trocar	250 mm		1
A-5040.90		1.7	0.6 mm	trocar	100 mm		10
A-5040.90 / 1	A-5040.90 / 1S	1.7	0.6 mm	trocar	100 mm		1
A-5042.00		2.2	0.8 mm	lancet	100 mm		10
	A-5042.00 / 1S	2.2	0.8 mm	lancet	100 mm		1
A-5042.10		3.0	1.1 mm	lancet	100 mm		10
	A-5042.10 / 1S	3.0	1.1 mm	lancet	100 mm		1
A-5043.00		2.2	0.8 mm	2 x trocar	100 mm		10
	A-5043.00 / 1S	2.2	0.8 mm	2 x trocar	100 mm		1
A-5043.10		3.0	1.1 mm	2 x trocar	100 mm		10
	A-5043.10 / 1S	3.0	1.1 mm	2 x trocar	100 mm		1
A-5043.90		1.7	0.6 mm	2 x trocar	100 mm		10
A-5043.90 / 1	A-5043.90 / 1S	1.7	0.6 mm	2 x trocar	100 mm		1
A-5044.30		4.0	1.25 mm	trocar / threaded	200 mm	10 mm	10
A-5044.30 / 1	A-5044.30 / 1S	4.0	1.25 mm	trocar / threaded	200 mm	10 mm	1
A-5044.42		5.0	1.6 mm	trocar / threaded	200 mm	10 mm	10
	A-5044.42 / 1S	5.0	1.6 mm	trocar / threaded	200 mm	10 mm	1
A-5044.74		7.0	2.2 mm	trocar / threaded	250 mm	10 mm	10
	A-5044.74 / 1S	7.0	2.2 mm	trocar / threaded	250 mm	10 mm	1

## Click-on Parallel K-Wire Guide



Art. No.	System Size	Description	Length	Pieces / Pkg
A-2027	2.2 / 3.0	for drill guides A-2725 and A-2825	20 mm	1

## Soft Tissue Protection



A-2225



A-2824



A-2007



A-8004.23



A-8004.25



A-8004.24



A-8000.23



A-8000.25



A-8000.24



A-2725



A-2825



A-2039



A-8001.23



A-8001.25



A-8001.24

Art. No.	System Size	CCS / headedCCS	Description	Pieces / Pkg
A-2007	2.2 / 3.0	CCS / headedCCS	K-wire guide, percutaneous	1
A-2225	1.7	CCS	K-wire guide / protection sleeve	1
A-2039	2.2 / 3.0	CCS	protection sleeve	1
A-2725	2.2	CCS	drill guide	1
A-2824	2.2 / 3.0	CCS / headedCCS	K-wire guide / protection sleeve	1
A-2825	3.0	CCS	drill guide	1
A-8000.23	5.0	CCS / headedCCS	protection sleeve, AO Quick Coupling	1
A-8000.24	5.0	CCS / headedCCS	trocar for A-8000.23	1
A-8000.25	5.0	CCS / headedCCS	K-wire guide for A-8000.23	1
A-8001.23	7.0	CCS / headedCCS	protection sleeve, AO Large Quick Coupling	1
A-8001.24	7.0	CCS / headedCCS	trocar for A-8001.23	1
A-8001.25	7.0	CCS / headedCCS	K-wire guide for A-8001.23	1
A-8004.23	4.0	CCS / headedCCS	protection sleeve, AO	1
A-8004.24	4.0	CCS / headedCCS	trocar for A-8004.23	1
A-8004.25	4.0	CCS / headedCCS	K-wire guide for A-8004.23	1

## Depth Gauges



A-2235



A-2835



A-8004.27



A-8000.27



A-8001.27

Art. No.	System Size	Description	Length	Pieces / Pkg
A-2235	1.7	for K-wire with $\varnothing$ 0.6 mm and length 100 mm	110 mm	1
A-2835	2.2 / 3.0	for K-wire with $\varnothing$ 0.8 mm / 1.1 mm and length 100 mm	110 mm	1
A-8000.27	5.0	for K-wire with $\varnothing$ 1.6 mm and length 200 mm	193 mm	1
A-8001.27	7.0	for K-wire with $\varnothing$ 2.2 mm and length 250 mm	223 mm	1
A-8004.27	4.0	for K-wire with $\varnothing$ 1.25 mm and length 200 mm	192 mm	1

## Handles, Cannulated



A-2073



A-2077



A-8000.20



A-8001.10

Art. No.	System Size	Description	Length	for Shaft End	Pieces / Pkg
A-2073	1.7 / 2.2 / 3.0	with twist cap	125 mm	AO Quick Coupling	1
A-2077	4.0		129 mm	AO Quick Coupling	1
A-8000.20	5.0		151 mm	AO Quick Coupling	1
A-8001.10	7.0		171 mm	AO Large Quick Coupling	1

## Screwdriver Blades, Cannulated, Self-Holding

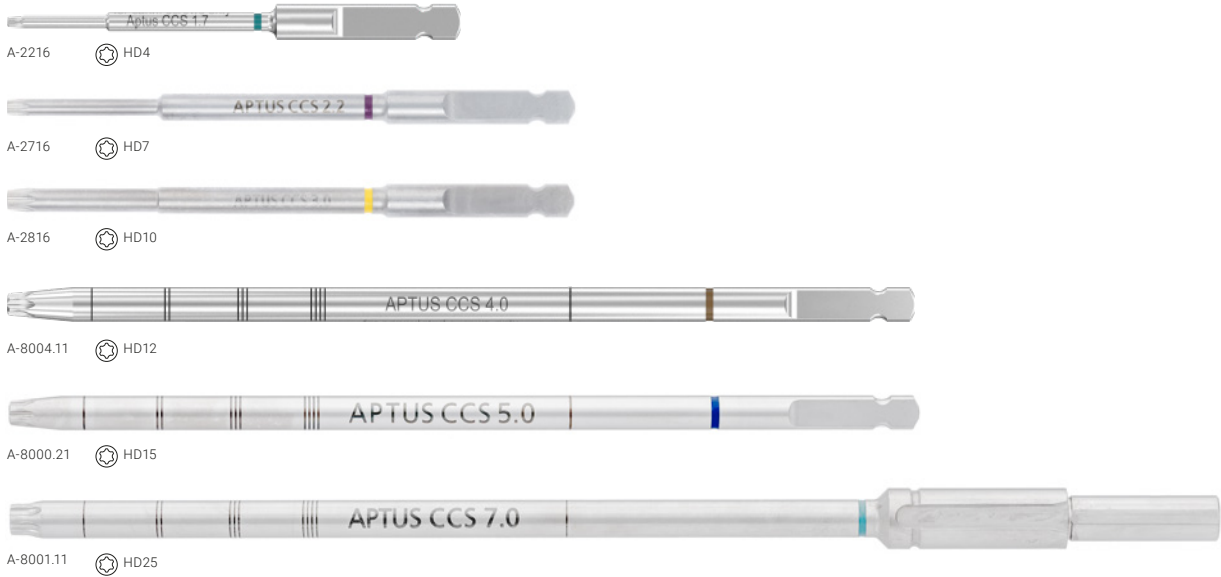

Art. No.	System Size	Interface	Description	Length	Shaft End	Pieces / Pkg
A-2216	1.7	HD4	for K-wire Ø 0.6 mm and length 100 mm	60 mm	AO Quick Coupling	1
A-2716	2.2	HD7	for K-wire Ø 0.8 mm and length 100 mm	75 mm	AO Quick Coupling	1
A-2816	3.0	HD10	for K-wire Ø 1.1 mm and length 100 mm	75 mm	AO Quick Coupling	1
A-8000.21	5.0	HD15	for K-wire Ø 1.6 mm and length 200 mm	120 mm	AO Quick Coupling	1
A-8001.11	7.0	HD25	for K-wire Ø 2.2 mm and length 250 mm	160 mm	AO Large Quick Coupling	1
A-8004.11	4.0	HD12	for K-wire Ø 1.25 mm and length 200 mm	120 mm	AO Quick Coupling	1

## Cleaning Styluses

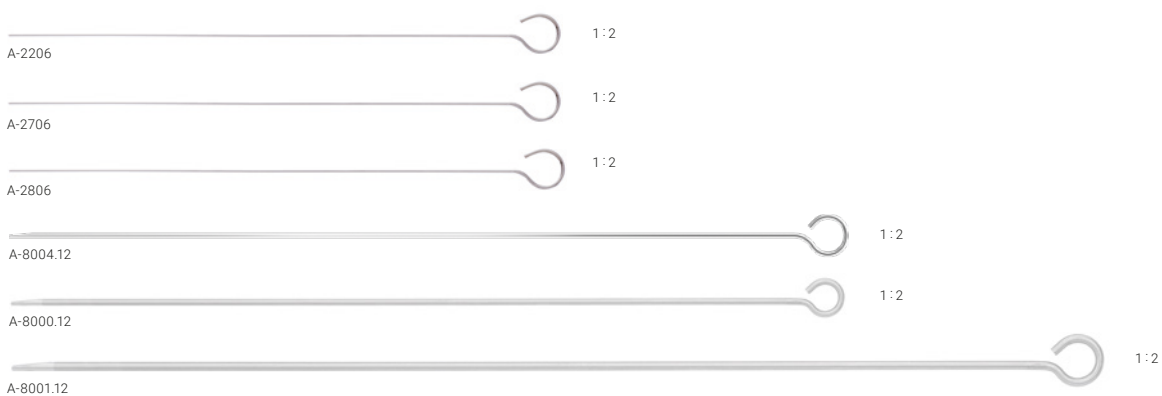

Art. No.	System Size	Ø	Length	Pieces / Pkg
A-2206	1.7	0.6 mm	147 mm	1
A-2706	2.2	0.8 mm	147 mm	1
A-2806	3.0	1.1 mm	148 mm	1
A-8000.12	5.0	1.6 mm	222 mm	1
A-8001.12	7.0	2.3 mm	291 mm	1
A-8004.12	4.0	1.3 mm	222 mm	1

## Periosteal Elevator



Art. No.	Width	Length	Pieces / Pkg
A-7011	3 mm	185 mm	1

## Bone Holding Clamp for Scarf Osteotomies



Art. No.	Length	Pieces / Pkg
A-2065	147 mm	1

## Cases, Trays – CCS 1.7

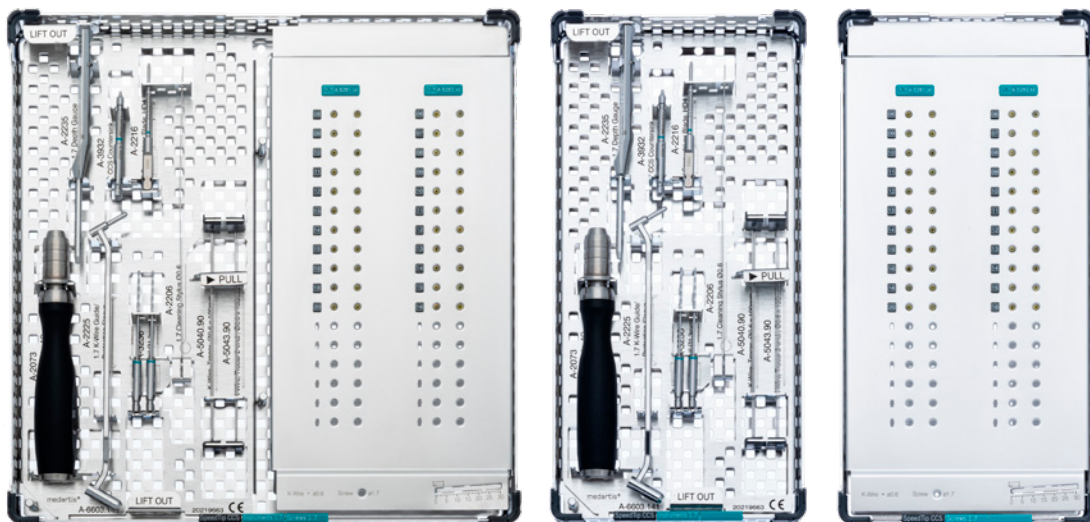

A-6603.121 with A-6603.141  
(excl. instruments and implants)

A-6603.131 with A-6603.141  
(excl. instruments and K-wires)

A-6603.111  
(excl. implants)

Art. No.	Description	Dimension (W x L)	Pieces / Pkg
A-6603.111	implant case APTUS CCS 1.7	120 x 240 mm	1
A-6603.121	implant / instrument case APTUS CCS 1.7	240 x 240 mm	1
A-6603.131	instrument case APTUS CCS 1.7	120 x 240 mm	1
A-6603.141	instrument tray APTUS CCS 1.7 for A-6603.121 or A-6603.131	120 x 240 mm	1
M-6726	lid for implant and instrument case	120 x 240 mm	1
M-6727	lid for implant and instrument case	240 x 240 mm	1

## Cases, Trays – CCS 2.2, 3.0

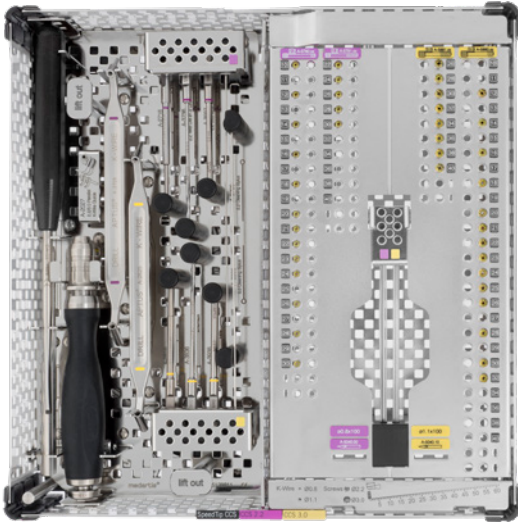

A-6603.001 with A-6603.042  
(excl. instruments and implants)



A-6603.031 with A-6603.042  
(excl. instruments)

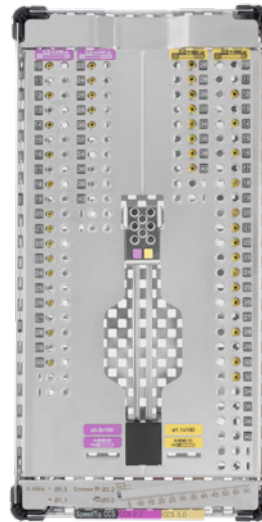

A-6603.011  
(excl. implants and K-wires)

Art. No.	Description	Dimension (W × L)	Pieces /Pkg
A-6603.001	implant / instrument case APTUS CCS 2.2, 3.0	240 × 240 mm	1
A-6603.003	implant / instrument case APTUS CCS 2.2, 3.0	240 × 240 mm	1
A-6603.004	implant / instrument case APTUS CCS 2.2, 3.0	240 × 240 mm	1
A-6603.011	implant case APTUS CCS 2.2, 3.0	120 × 240 mm	1
A-6603.013	implant case APTUS CCS 2.2, 3.0	120 × 240 mm	1
A-6603.014	implant case APTUS CCS 2.2, 3.0	120 × 240 mm	1
A-6603.021	implant / instrument case APTUS CCS 2.2, 3.0, small	120 × 240 mm	1
A-6603.022	implant / instrument case APTUS CCS 2.2, 3.0, small	120 × 240 mm	1
A-6603.023	implant / instrument case APTUS CCS 2.2, 3.0, small	120 × 240 mm	1
A-6603.025	implant / instrument case APTUS CCS 2.2, 3.0, small	120 × 240 mm	1
A-6603.026	implant / instrument case APTUS CCS 2.2, 3.0, small	120 × 240 mm	1
A-6603.031	instrument case APTUS CCS 2.2, 3.0, in combination with any A-6603.01x	120 × 240 mm	1
A-6603.041	instrument tray APTUS CCS 2.2, 3.0, lower, for A-6603.00x or A-6603.031	120 × 240 mm	1
A-6603.042	instrument tray APTUS CCS 2.2, 3.0, upper, for A-6603.00x or A-6603.031	120 × 240 mm	1
A-6603.052	instrument tray APTUS CCS 2.2, 3.0, upper, small, for A-6603.02x	60 × 240 mm	1
A-6603.053	instrument tray APTUS CCS 2.2, 3.0, lower, small, for A-6603.02x	60 × 240 mm	1
A-6603.054	instrument tray APTUS CCS 2.2, 3.0, lower, small, for A-6603.02x	60 × 240 mm	1
M-6706	lid for implant and instrument case	120 × 240 mm	1
M-6707	lid for implant and instrument case	240 × 240 mm	1



### Cases, Trays – headedCCS 2.2, 3.0



A-6603.071 with A-6603.043  
(excl. instruments and implants)



A-6603.081 with A-6603.043  
(excl. instruments)

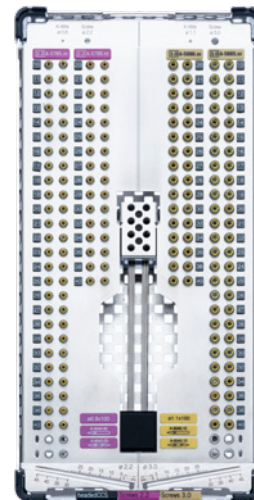

A-6603.061  
(excl. implants and K-wires)

Art. No.	Description	Dimension (W x L)	Pieces /Pkg
A-6603.043	instrument tray APTUS headedCCS 2.2,3.0, for A-6603.071 or A-6603.081	120 x 240 mm	1
A-6603.061	implant case APTUS headedCCS 2.2,3.0	120 x 240 mm	1
A-6603.071	implant/instrument case APTUS headedCCS 2.2,3.0	240 x 240 mm	1
A-6603.081	instrument case APTUS headedCCS 2.2,3.0	120 x 240 mm	1
M-6726	lid for implant and instrument case	120 x 240 mm	1
M-6727	lid for implant and instrument case	240 x 240 mm	1

### Cases, Trays – CCS 4.0

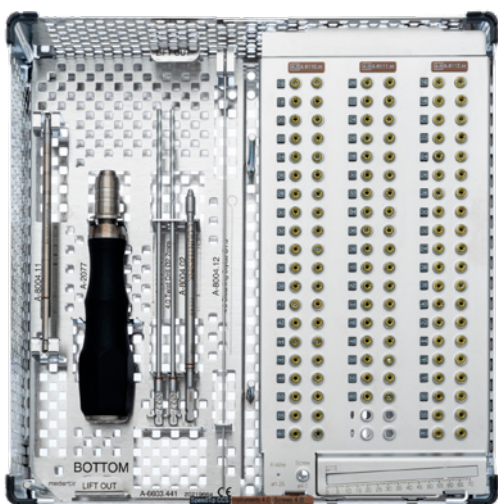

A-6603.421 with A-6603.441  
(excl. instruments and implants)



A-6603.442  
(excl. instruments and K-wires)



A-6603.431 with A-6603.441  
(excl. instruments)

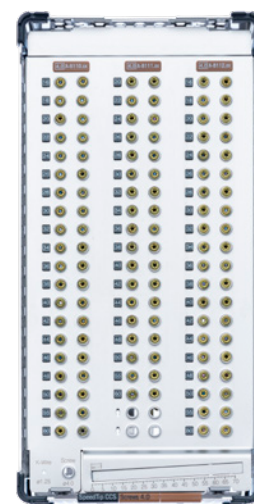

A-6603.411  
(excl. implants)

Art. No.	Description	Dimension (W x L)	Pieces /Pkg
A-6603.411	implant case APTUS CCS 4.0	120 x 240 mm	1
A-6603.421	implant/instrument case APTUS CCS 4.0	240 x 240 mm	1
A-6603.431	instrument case APTUS CCS 4.0	120 x 240 mm	1
A-6603.441	instrument tray APTUS CCS 4.0, lower, for A-6603.421 or A-6603.431	120 x 240 mm	1
A-6603.442	instrument tray APTUS CCS 4.0, upper, for A- A-6603.421 or A-6603.431	120 x 240 mm	1
M-6726	lid for implant and instrument case	120 x 240 mm	1
M-6727	lid for implant and instrument case	240 x 240 mm	1



### Cases, Trays – headedCCS 4.0

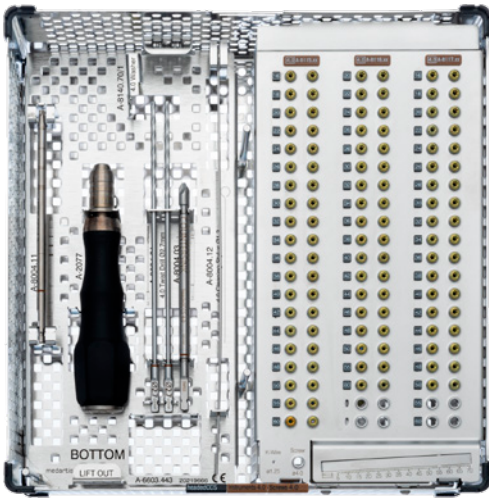

A-6603.471 with A-6603.443  
(excl. instruments and implants)



A-6603.442  
(excl. instruments and K-wires)



A-6603.481 with A-6603.443  
(excl. instruments)

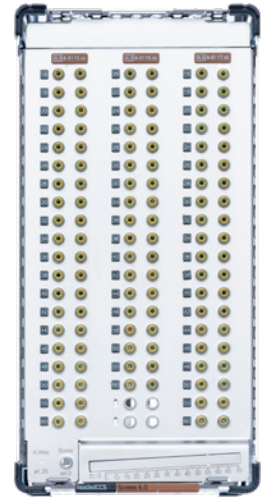

A-6603.461  
(excl. implants)

Art. No.	Description	Dimension (W x L)	Pieces / Pkg
A-6603.442	instrument tray APTUS CCS 4.0, upper, for A-6603.471 or A-6603.481	120 x 240 mm	1
A-6603.443	instrument tray APTUS headedCCS 4.0, lower, for A-6603.471 or A-6603.481	120 x 240 mm	1
A-6603.461	implant case APTUS headedCCS 4.0	120 x 240 mm	1
A-6603.471	implant/instrument case APTUS headedCCS 4.0	240 x 240 mm	1
A-6603.481	instrument case APTUS headedCCS 4.0	120 x 240 mm	1
M-6726	lid for implant and instrument case	120 x 240 mm	1
M-6727	lid for implant and instrument case	240 x 240 mm	1

### Cases, Trays – CCS 5.0

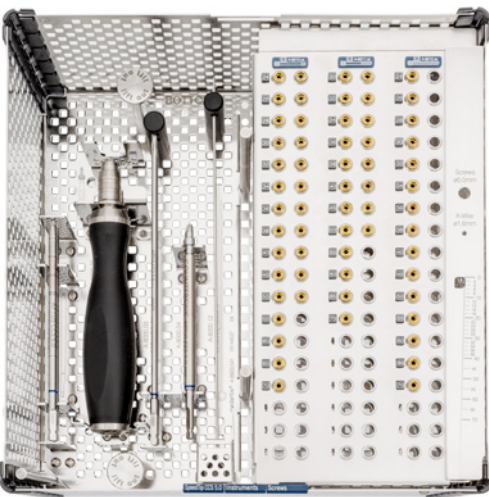

A-6603.511 with A-6603.541  
(excl. instruments and implants)



A-6603.542  
(excl. instruments and K-wires)



A-6603.531 with A-6603.541  
(excl. instruments)

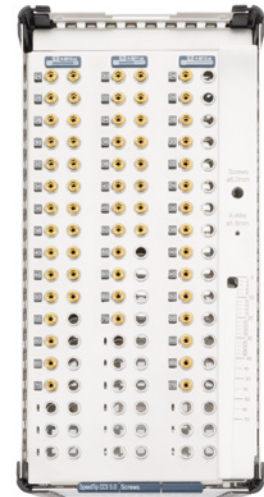

A-6603.521  
(excl. implants)

Art. No.	Description	Dimension (W x L)	Pieces / Pkg
A-6603.511	implant/instrument case APTUS CCS 5.0	240 x 240 mm	1
A-6603.521	implant case APTUS CCS 5.0	120 x 240 mm	1
A-6603.531	instrument case APTUS CCS 5.0	120 x 240 mm	1
A-6603.541	instrument tray APTUS CCS 5.0, lower, for A-6603.511 or A-6603.531	120 x 240 mm	1
A-6603.542	instrument tray APTUS CCS 5.0, upper, for A-6603.511 or A-6603.531	120 x 240 mm	1
M-6706	lid for implant and instrument case	120 x 240 mm	1
M-6707	lid for implant and instrument case	240 x 240 mm	1

### Cases, Trays – headedCCS 5.0



A-6603.571 with A-6603.543  
(excl. instruments and implants)

A-6603.542  
(excl. instruments and K-wires)

A-6603.581 with A-6603.543  
(excl. instruments)

A-6603.561  
(excl. implants)

Art. No.	Description	Dimension (W × L)	Pieces / Pkg
A-6603.542	instrument tray APTUS CCS 5.0, upper, for A-6603.571 or A-6603.581	120 × 240 mm	1
A-6603.543	instrument tray APTUS headedCCS 5.0, lower, for A-6603.571 or A-6603.581	120 × 240 mm	1
A-6603.561	implant case APTUS headedCCS 5.0	120 × 240 mm	1
A-6603.571	implant/instrument case APTUS headedCCS 5.0	240 × 240 mm	1
A-6603.581	instrument case APTUS headedCCS 5.0	120 × 240 mm	1
M-6726	lid for implant and instrument case	120 × 240 mm	1
M-6727	lid for implant and instrument case	240 × 240 mm	1

### Cases, Trays – CCS 7.0



A-6603.731 with A-6603.741  
(excl. instruments and implants)

A-6603.742  
(excl. instrument and K-wires)

A-6603.721  
(excl. implants)

Art. No.	Description	Dimension (W × L)	Pieces / Pkg
A-6603.721	implant case APTUS CCS 7.0	240 × 240 mm	1
A-6603.731	instrument case APTUS CCS 7.0	240 × 240 mm	1
A-6603.741	instrument tray APTUS CCS 7.0, lower, for A-6603.731	240 × 240 mm	1
A-6603.742	instrument tray APTUS CCS 7.0, upper, for A-6603.731	240 × 240 mm	1
M-6707	lid for implant and instrument case	240 × 240 mm	1



## Cases, Trays – headedCCS 7.0



A-6603.781 with A-6603.743  
(excl. instruments and implants)



A-6603.742  
(excl. instrument and K-wires)

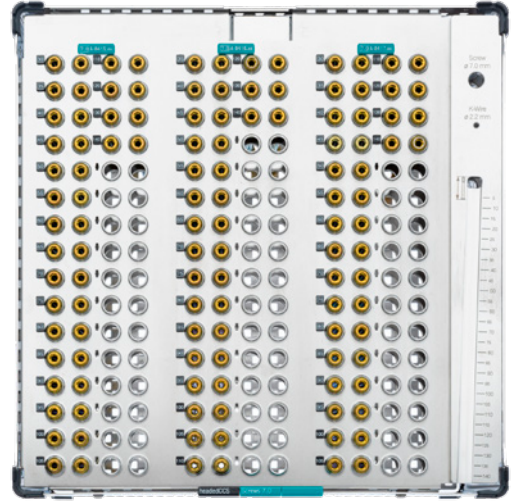

A-6603.761  
(excl. implants)

Art. No.	Description	Dimension (W × L)	Pieces / Pkg
A-6603.742	instrument tray APTUS CCS 7.0, upper, for A-6603.781	240 × 240 mm	1
A-6603.743	instrument tray APTUS headedCCS 7.0, lower, for A-6603.781	240 × 240 mm	1
A-6603.761	implant case APTUS headedCCS 7.0	240 × 240 mm	1
A-6603.781	instrument case APTUS headedCCS 7.0	240 × 240 mm	1
M-6727	lid for implant and instrument case	240 × 240 mm	1

## Storage and Transportation\*

Art. No.	Description	Dimension (W × L × H)	Pieces / Pkg
A-6610.50	storage container	265 × 257 × 238 mm	1
A-6611	lid for storage container A-6610.50	265 × 257 × 238 mm	1
M-6710	holding rack for implant and instrument cases, for case 240 × 240 mm	252 × 243 × 143 mm	1
M-6720	holding rack for implant and instrument cases, for case 240 × 240 mm	252 × 243 × 245 mm	1

## Articles available on request

A-5040.00/1	A-5044.74/1
A-5040.10/1	A-6603.044
A-5040.42/1	A-8410.30/1
A-5040.74/1	A-8410.35/1
A-5042.00/1	A-8411.35/1
A-5042.10/1	A-8412.30/1
A-5043.00/1	A-8412.35/1
A-5043.10/1	
A-5044.42/1	

\*Not available in all countries

R\_CCS-01010001\_v3 / © 2022-09, Medartis AG, Switzerland. All technical data subject to alteration.

#### MANUFACTURER & HEADQUARTERS

Medartis AG | Hochbergerstrasse 60E | 4057 Basel / Switzerland

P +41 61 633 34 34 | F +41 61 633 34 00 | [www.medartis.com](http://www.medartis.com)

#### SUBSIDIARIES

Australia | Austria | Brazil | France | Germany | Japan | Mexico | New Zealand | Poland | Spain | UK | USA

For detailed information regarding our subsidiaries and distributors, please visit [www.medartis.com](http://www.medartis.com)

**CE CE**  
0197

**UK UK**  
**CA CA**  
0086

Disclaimer: This information is intended to demonstrate the Medartis portfolio of medical devices. A surgeon must always rely on her or his own professional clinical judgement when deciding whether to use a particular product when treating a particular patient. Medartis is not giving any medical advice. The devices may not be available in all countries due to registration and/or medical practices. For further questions, please contact your Medartis representative ([www.medartis.com](http://www.medartis.com)). This information contains products with CE and/or UKCA-marking. All pictures shown are for illustration purposes only and may not be an exact representation of the product. For US only: Federal law restricts this device to sale by or on the order of a physician.