

medartis

PRECISION IN FIXATION

SURGICAL TECHNIQUE

Clavicle System 2.8

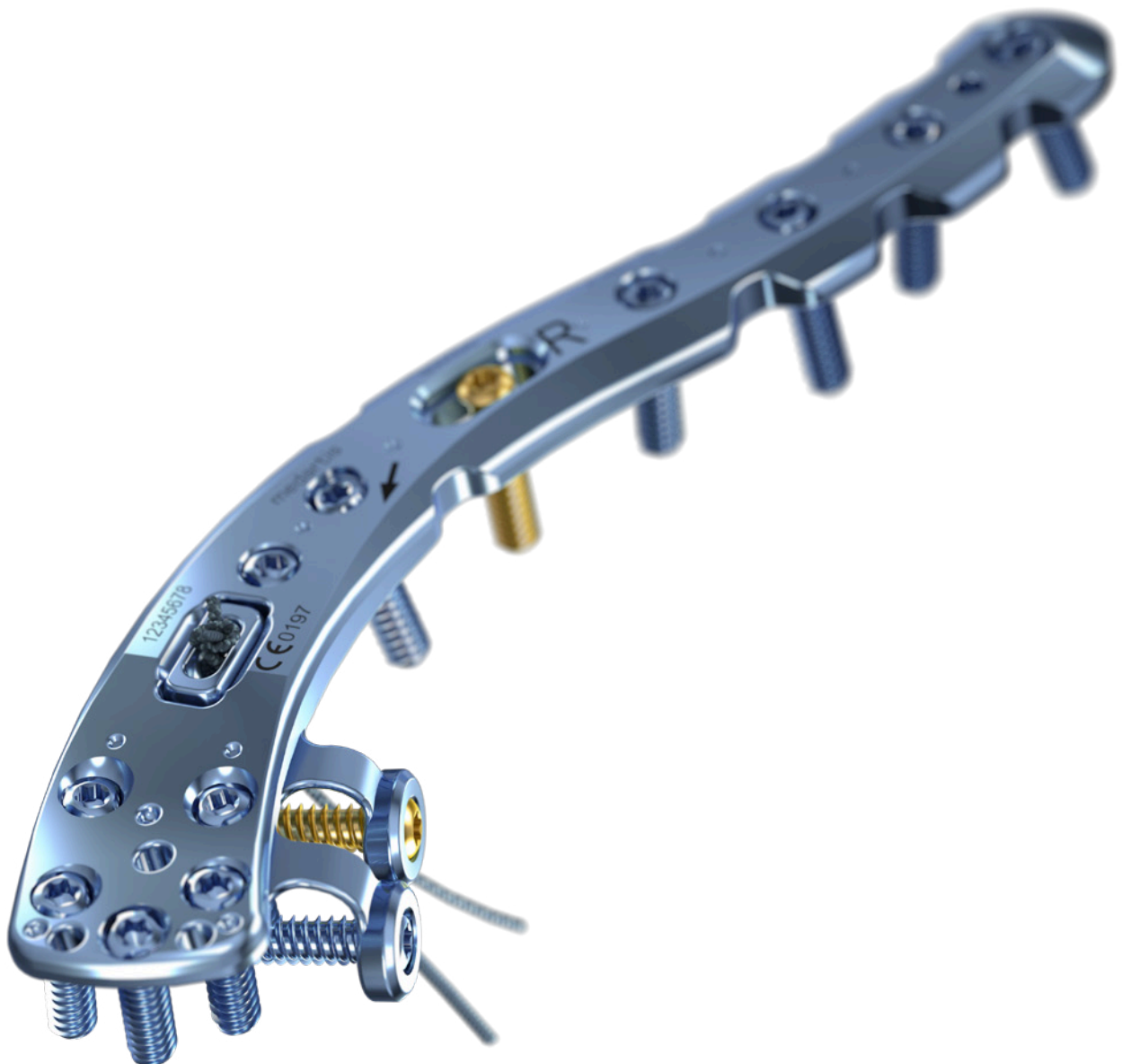

APTUS Shoulder

Contents

3	Introduction
3	Product Materials
3	Indications
3	Contraindications
3	Color Coding
3	Possible Combination of Plates and Screws
3	Symbols
4	System Overview
5	Treatment Concept
6	Instrument Application
6	General Instrument Application
6	Sizing Templates
7	Bending
8	Drilling
10	Assigning the Screw Length
11	Thread Preparation with the Tap
12	Screw Pick-Up
13	Specific Instrument Application
13	Drill Guide Blocks
14	Surgical Techniques
14	General Surgical Techniques
14	Lag Screw Technique
15	TriLock ^{PLUS}
16	Specific Surgical Techniques
16	Clavicle Plates
18	Superior Lateral Plates
21	Suture Fixation on Superior Lateral Plates
23	Cortical Screw Fixation on Superior Lateral Plates
24	Explanation
24	Explanation of Clavicle Plates
24	Explanation of Insert for Suture Fixation
25	Explanation of Screw and Insert for Cortical Screw Fixation
26	TriLock Locking Technology
26	Correct Application of the TriLock Locking Technology
27	Correct Locking ($\pm 15^\circ$) of the TriLock Screws in the APTUS Clavicle System 2.8
28	Implants, Instruments and Containers

For further information regarding the APTUS product line visit www.medartis.com

Introduction

Product Materials

Plates	Titanium alloy
Inserts	Titanium alloy
Screws	Titanium alloy
K-wires	Stainless steel
Instruments	Stainless steel, PEEK, aluminum, Nitinol, silicone or titanium
Containers	Stainless steel, aluminum, PEEK, polyphenylsulfone, polyurethane, silicone

Indications

APTUS Shoulder

Fractures and osteotomies of the bones of the shoulder

- Clavicle plates
- fractures, osteotomies, malunions and non-unions of the clavicle

Contraindications

- Preexisting or suspected infection at or near the implantation site
- Known allergies and/or hypersensitivity to implant materials
- Inferior or insufficient bone quality to securely anchor the implant
- Patients who are incapacitated and/or uncooperative during the treatment phase
- Growth plates are not to be blocked with plates and screws

Color Coding

System Size	Color Code
APTUS 2.8	Orange

Plates and Screws

Special implant plates and screws have their own color:

Implant plates blue	TriLock plates (locking)
Implant screws gold	Cortical screws (fixation)
Implant screws blue	TriLock screws (locking)
Implant insert blue	Suture fixation insert for superior lateral plates
Implant insert gold	Cortical screw insert for superior lateral plates

Possible Combination of Plates and Screws

Plates and screws can be combined within one system size:

2.8 TriLock Plates

2.8 Cortical Screws, HexaDrive 7

2.8 TriLock Screws, HexaDrive 7

Symbols



HexaDrive



System Overview

The implant plates of the APTUS Clavicle System 2.8 are available in the following designs:

Superior Midshaft Plates

A-4851.21-32

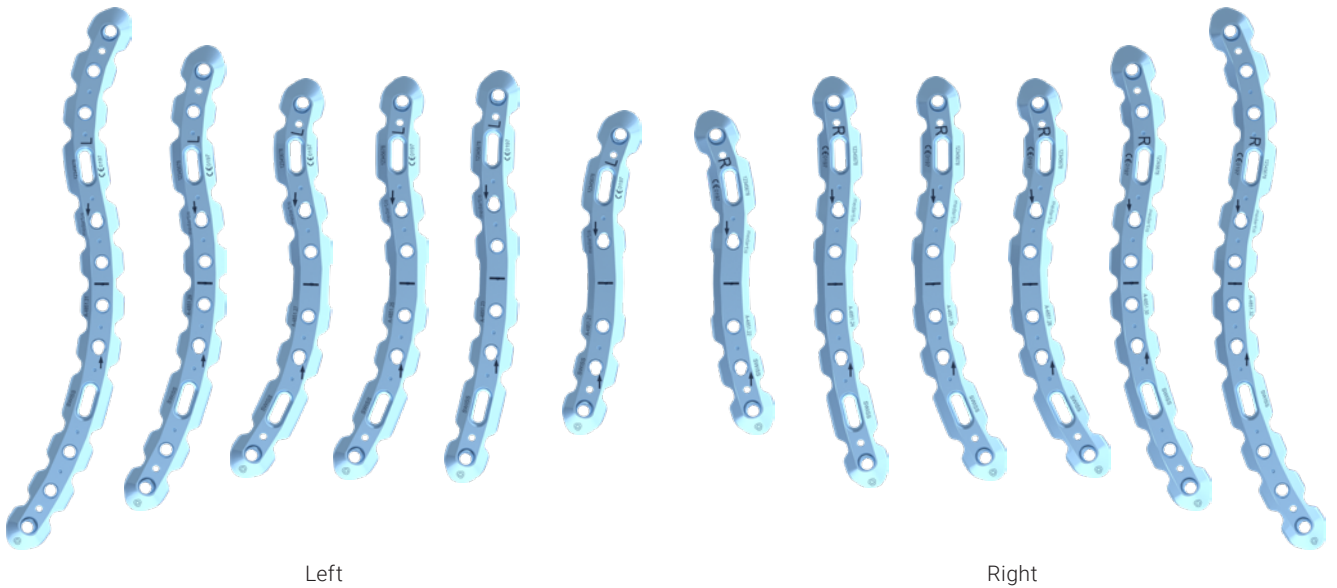

Superior Lateral Shaft Plates

A-4851.11-12

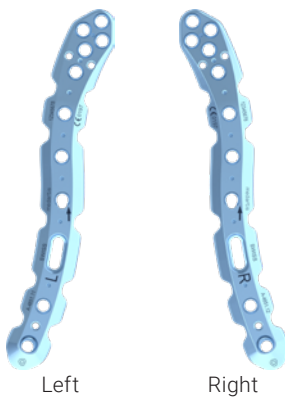

Superior Lateral Plates

A-4851.01-04

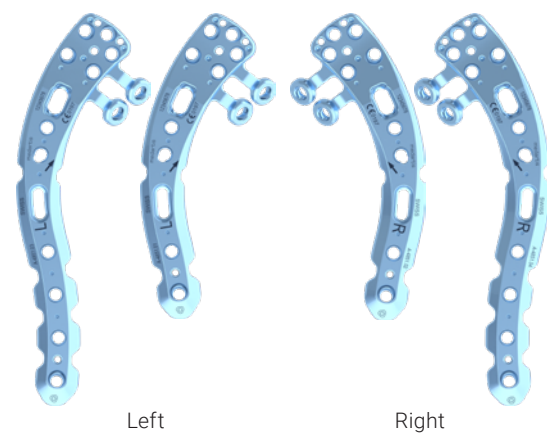

Anterior Midshaft Plates

A-4851.41-43

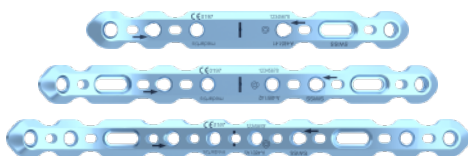



Anterior Lateral Plate

A-4851.51



Treatment Concept

The table below lists typical clinical findings which can be treated with the implants of the APTUS Shoulder Clavicle System 2.8.

Fracture zone	<p>Midshaft</p> 	<p>Lateral third to midshaft</p> 	<p>Lateral third</p> 
Fracture type	Fractures of the midshaft of the clavicle.	Fractures extending from the lateral third of the clavicle to the midshaft, without disruption of the coracoclavicular (CC) ligaments.	Fractures involving the distal end of the clavicle up to the acromioclavicular (AC) joint with coracoclavicular (CC) ligament intact or disrupted.*
Plate types recommended			
	<p>Superior Midshaft Plates (A-4851.21-32)</p> <p>Anterior Midshaft Plates (A-4851.41-43)</p>	<p>Superior Lateral Shaft Plates (A-4851.11-12)</p>	<p>Superior Lateral Plates (A-4851.01-04)</p> <p>Anterior Lateral Plate (A-4851.51)</p> <p>*Fractures requiring suture fixation through plate: Superior Lateral Plates only (A-4851.01-04)</p>

The above-mentioned information is a recommendation only. The operating surgeon is solely responsible for the choice of the suitable implant for the specific case.

Instrument Application

General Instrument Application

Sizing Templates

Sizing templates facilitate the intraoperative selection of the appropriate implant.

Sizing templates for the 2.8 Clavicle Plates are available according to chapter “Implants, Instruments and Containers”.

The sizing templates feature K-wire holes that indicate the position of the screw holes on the respective implant.

If necessary, use the K-wire holes to temporarily attach the template to the bone with 1.6 mm K-wires (A-5040.41, A-5042.41) or olive K-wires (A-5045.41/1).

The article number of the sizing template (e.g. A-4851.25TP) corresponds to the article number of the sterile implant (e.g. A-4851.25S). The suffix TP stands for template.



A-4851.25TP
Template for A-4851.25



Notice

Do not implant sizing templates.

Do not bend or cut sizing templates.

Bending

If required, the plates (A-4851.01–51) can be bent with the plate bending irons (A-2091.01 and A-2091.02).

The plate bending irons have different slots to enable twisting and bending of the plates in and out of the plate plane.

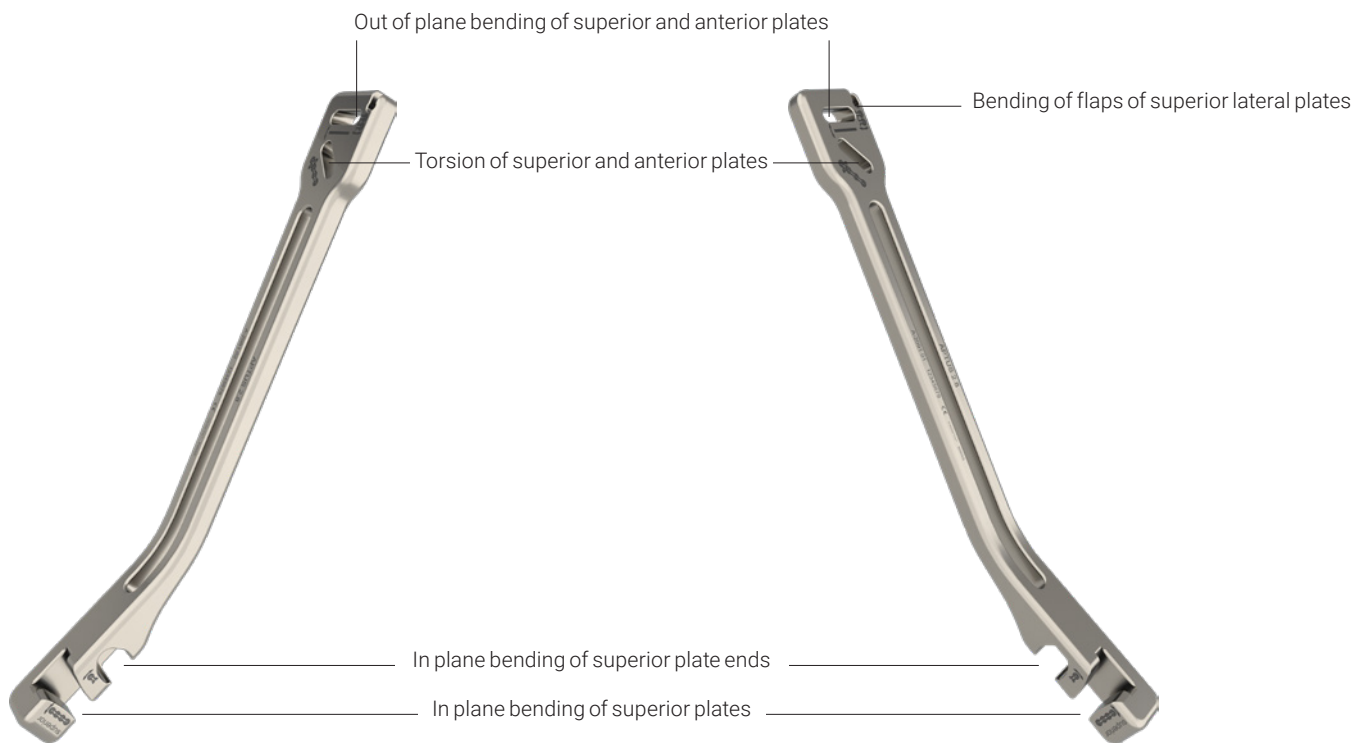

A-2091.02
Plate Bending Iron Clavicle 2/2

A-2091.01
Plate Bending Iron Clavicle 1/2

Warning

Wrong bending of the plate may lead to impaired functionality and post-operative construct failure.

While bending, the plate must always be held at two adjacent holes to prevent contour deformation of the intermediate plate hole.

The plate bending irons must not come into contact during twisting.

Avoid bending or contouring directly over a plate section that will eventually be crossing the fracture line.

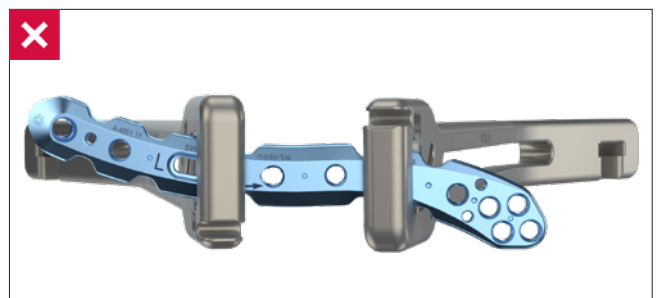

Warning

Do not bend the plate by more than 30°. Bending the plate further may deform the plate holes and may cause the plate to break postoperatively.

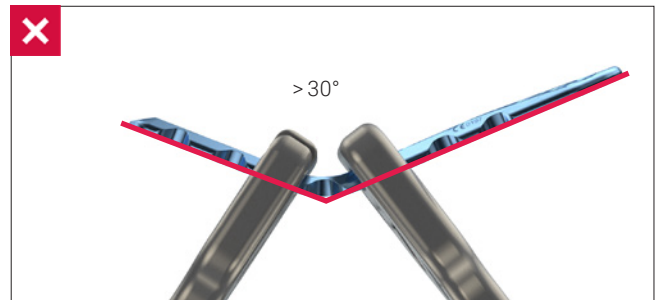

Warning

Repeatedly bending the plate in opposite directions may cause the plate to break postoperatively.



Drilling

Color-coded twist drills are available for every APTUS system size. All twist drills are color coded with a ring system.

System Size	Color Code
APTUS 2.8	Orange

There are two different types of twist drills for the system size 2.8: The core hole drill is characterized by one colored ring. The gliding hole drill (for lag screw technique) is characterized by two colored rings.



A-3832
Core hole drill with Ø2.35 mm = one colored ring



A-3834
Gliding hole drill with Ø2.9 mm = two colored rings

Warning

The twist drill must always be guided by the drill guide (A-2820) or the self-holding drill sleeve (A-2826). This prevents damage to the screw hole and protects the surrounding tissue from direct contact with the drill. The drill guide also serves to limit the pivoting angle.



A-2820
2.8 Drill Guide



A-2826
2.8 Drill Sleeve, Self-Holding

After positioning the plate, insert the drill guide and the twist drill into the screw hole.

The end with one orange bar of the double-ended drill guide (A-2820) can be used for all screw holes and for the insertion of independent screws (e.g. fragment fixation with screws alone).



The self-holding drill sleeve (A-2826) can be locked with a clockwise turn in the TriLock holes of the plate (no more than $\pm 15^\circ$). It thus performs all of the functions of a drill guide without the need to be held.

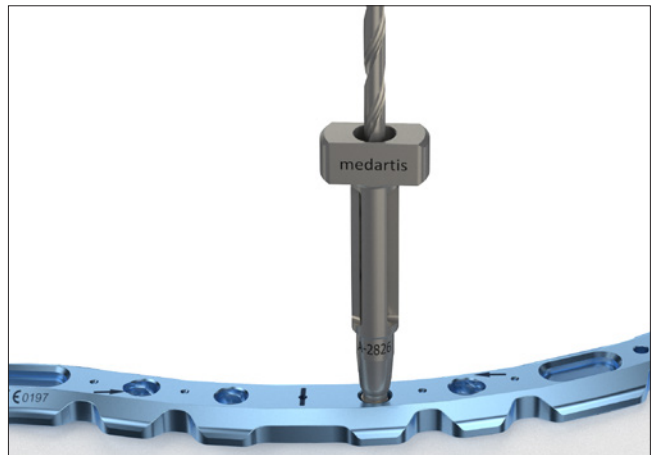

Warning

For TriLock plates ensure that the screw holes are predrilled with a pivoting angle of no more than $\pm 15^\circ$. For this purpose, the drill guide features a limit stop of $\pm 15^\circ$. A predrilled pivoting angle of $> 15^\circ$ no longer allows the TriLock screws to correctly lock in the plate.

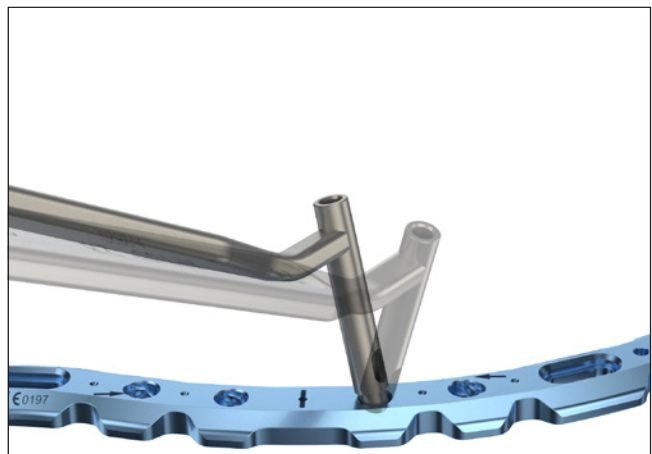

Assigning the Screw Length

The depth gauge (A-2031) is used to assign the ideal screw length for use in monocortical or bicortical screw fixation of TriLock screws and cortical screws.



A-2031
2.0-2.8 Depth Gauge

Retract the slider of the depth gauge.

The depth gauge caliper has a hooked tip that is either inserted to the bottom of the hole or is used to catch the far cortex of the bone. When using the depth gauge, the caliper stays static and only the slider is adjusted.

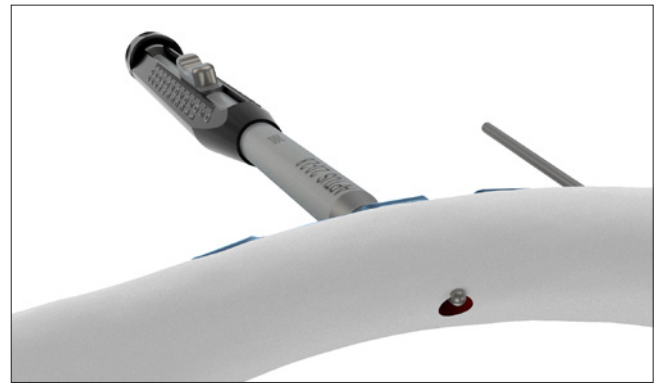

To assign the screw length, place the distal end of the slider onto the implant plate or directly onto the bone (e.g. for fracture fixation with lag screws).

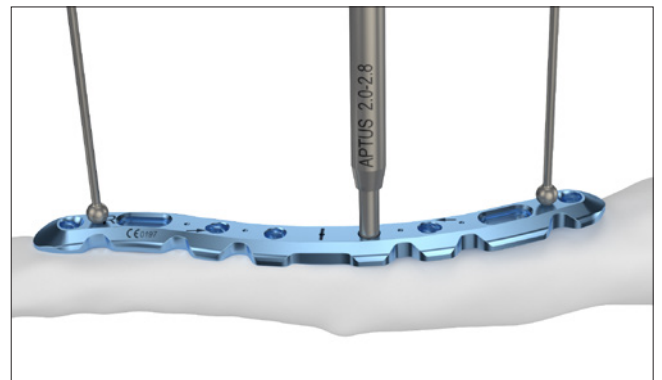

The ideal screw length for the assigned drill hole can be read on the scale of the depth gauge.

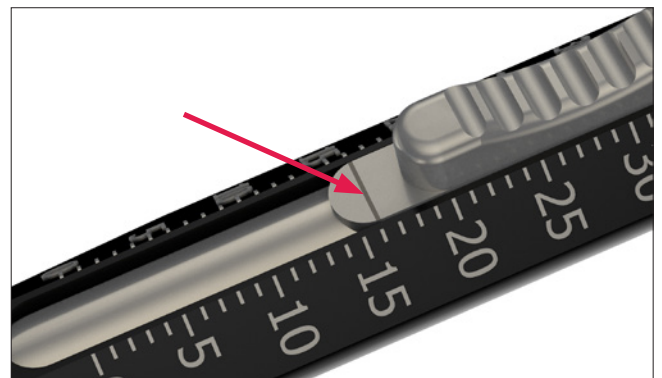

Thread Preparation with the Tap

Caution

All APTUS screws are self-tapping. In case of very hard bone, especially in the shaft region of the clavicle, it may be necessary to use the 2.8 tap (A-3839) to reduce the insertion torque of the 2.8 mm screws and to prevent fragment dislocation.



A-3839
2.8 Tap



A-2078
Handle with Quick Connector, AO

After drilling a core hole with the core hole drill (A-3832, one orange ring), create a thread for the screw using the 2.8 tap (A-3839) together with the handle (A-2078).

Assign the screw length and insert the corresponding screw with the screwdriver (screwdriver blade A-2013 with handle A-2078).

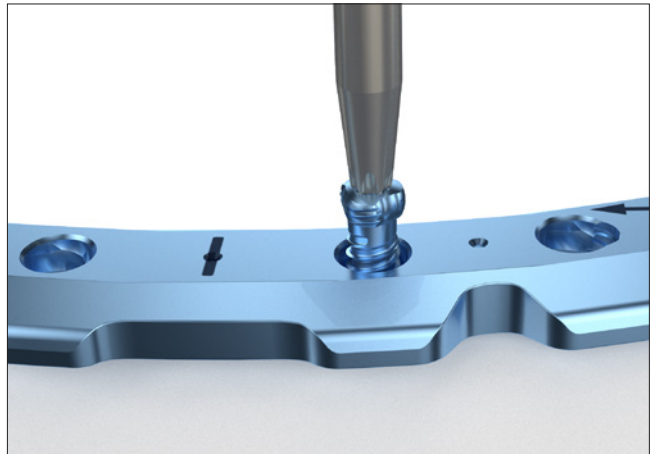

Screw Pick-Up

The screwdriver blade (A-2013) features the patented HexaDrive self-holding system.



A-2013
2.5/2.8 Screwdriver Blade, HD7, AO



A-2078
Handle with Quick Connector, AO

To remove the screws from the implant container, insert the appropriately color-coded screwdriver blade perpendicularly into the screw head of the desired screw and pick up the screw with axial pressure.

Notice

The screw will not hold without axial pressure.

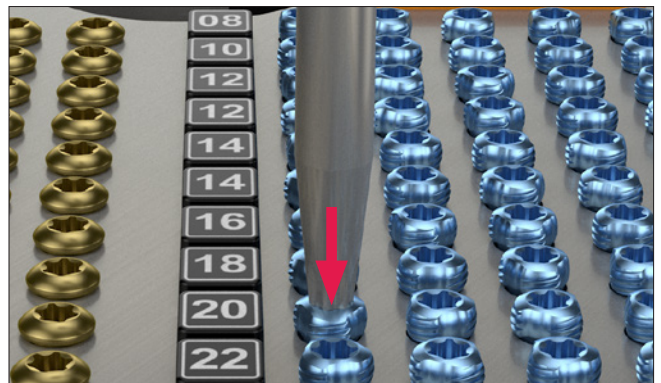

Caution

Vertically extract the screw from the compartment. Picking up the screw repeatedly may lead to permanent deformation of the self-retaining area of the HexaDrive inside the screw head. Therefore, the screw may no longer be able to be picked up correctly. In this case, a new screw has to be used.

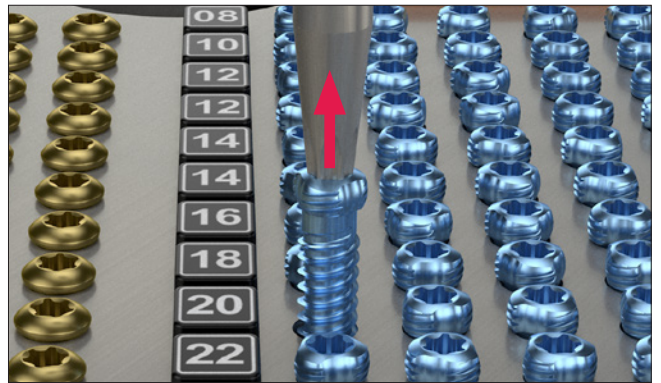

Notice

Check the screw length and diameter at the scale of the measuring module. The screw length is determined at the end of the screw head.

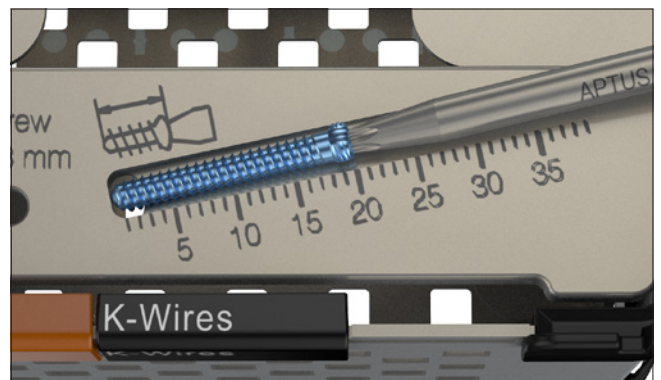

Specific Instrument Application

Drill Guide Blocks

The drill guide blocks (A-2823.01 for left plates and A-2823.02 for right plates) serve to rapidly and accurately position the superior screws in the superior lateral plates (A-4851.01–04). Thus there is no danger of collision of the superior screws. They are marked with L and R for the left and right side.



A-2823.01



A-2823.02

The drill guide (A-2820) or the self-holding drill sleeve (A-2826), the depth gauge (A-2031) as well as two K-wires (A-5040.41, A-5042.41) or olive K-wires (A-5045.41/1) with a diameter of 1.6 mm can be used together with the drill guide block. You can drill, measure and insert the screws through the holes of the attached drill guide block.



Drill Guide Block		Plates
Left	A-2823.01	A-4851.01 A-4851.03
Right	A-2823.02	A-4851.02 A-4851.04

Screw trajectories using the drill guide block for superior lateral plates (inferior view):

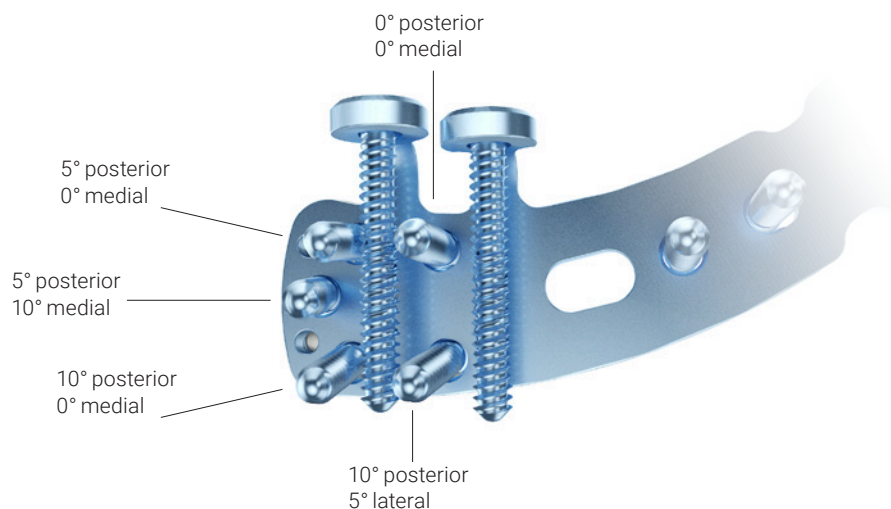

Surgical Techniques

General Surgical Techniques

Lag Screw Technique

Warning

Incorrect application of the lag screw technique(s) may result in postoperative loss of reduction.

1. Drilling the gliding hole

Drill the gliding hole using the twist drill marked with two orange rings (A-3834, Ø 2.9 mm) in combination with the end of the drill guide (A-2820) labeled with "LAG". Drill perpendicular to the fracture line.

Do not drill further than to the fracture line.

2. Drilling the core hole

Insert the other end of the drill guide (A-2820) into the drilled gliding hole and use the twist drill for core holes with one orange ring (A-3832, Ø 2.35 mm) to drill the core hole.

3. Compressing the fracture

Compress the fracture with the corresponding cortical screw (A-5800.xx).

4. Optional steps before compression

If required, use the countersink (A-3835) to create a recess in the bone for the screw head.

Caution

Use the handle (A-2078) instead of a power tool to reduce the risk of countersinking too far through the near cortex.

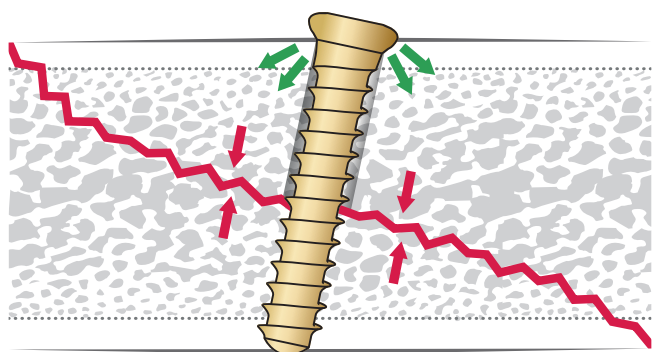

TriLock^{PLUS}

TriLock^{PLUS} holes are available on all clavicle plates.

TriLock^{PLUS} allows for 1 mm compression and angular stable locking in one step.

For this technique, a TriLock screw, the 2.5/2.8 drill guide TriLock^{PLUS} (A-2827) and a plate with a TriLock^{PLUS} hole are required. The TriLock^{PLUS} holes and the drill guide are both marked with an arrow indicating the direction of the compression. Before using a TriLock^{PLUS} hole, ensure that there is no fixation on the TriLock^{PLUS} side, and fix the plate with at least one TriLock screw on the opposite side of the fracture or osteotomy line.

1. Positioning the drill guide in the plate

Following the direction of the compression, insert the 2.5/2.8 drill guide TriLock^{PLUS} perpendicular to the plate. The arrow on the drill guide and the plate both indicate the direction of the compression.

Use the end of the drill guide that helps you avoid collision with the patient's anatomy.

Warning

Correct compression is only achieved if the drill guide is inserted in a 90° angle into the plate.

2. Drilling through the drill guide TriLock^{PLUS}

Use the twist drill for core holes with one orange ring (A-3832) to completely drill through the bone (bicortically).

3. Inserting the screw and locking in final position

Insert a TriLock screw into the predrilled hole. Axial compression starts as soon as the screw head touches the plate. The final position is reached when the screw is locked into the TriLock screw hole.

TriLock^{PLUS} holes can also be used as conventional TriLock holes allowing for multidirectional ($\pm 15^\circ$) and angular stable locking with TriLock screws or for the insertion of cortical screws. For conventional drilling, use the respective end of the drill guide (A-2820), see also chapter "Drilling".

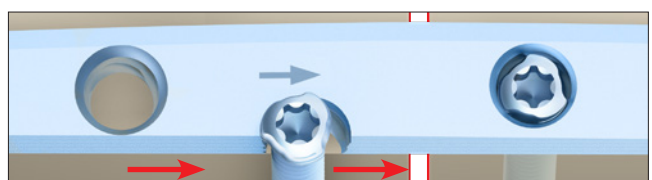
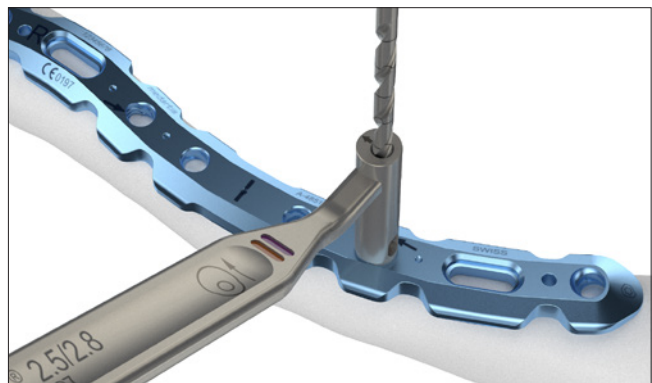

Specific Surgical Techniques

Clavicle Plates (A-4851.11–51)

Superior Midshaft Plates (A-4851.21–32)



A-4851.26

Superior Lateral Shaft Plates (A-4851.11 and A-4851.12)



A-4851.12

Anterior Midshaft Plates (A-4851.41–43)



A-4851.42

Anterior Lateral Plate (A-4851.51)



A-4851.51

1. Positioning the plate

After reduction of the fracture, select the appropriate clavicle plate (A-4851.xx). Position the plate centrally over the fracture, ideally leaving three screw holes lateral and medial to the fracture.

If required, bend the plate with the bending irons (A-2091.01–02) to achieve an adequate fit to the individual shape of the bone.

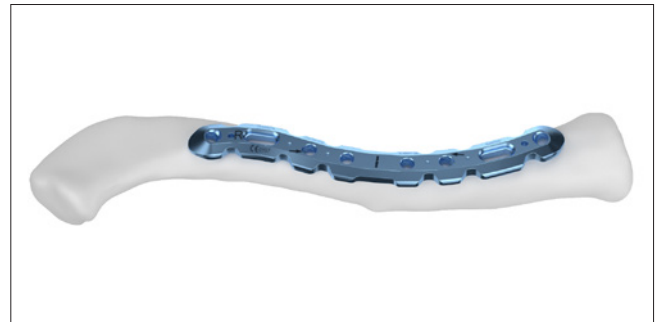

For temporary plate fixation, 1.6 mm K-wires (A-5040.41, A-5042.41) or olive K-wires (A-5045.41/1) may be used. Alternatively, plates that have dimples on the surface can be held to the bone by placing the tip of the pointed reduction forceps into one of the dimples.

Recommendation

Prior to placement of the plate, lag screw fixation across the major fracture fragments may be performed (see chapter “Lag Screw Technique”).

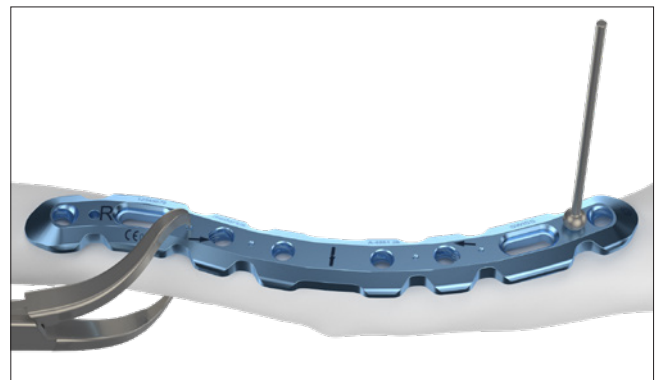

2. Fixation of the plate

Start the fixation with a golden cortical screw (A-5800.xx) in an oblong hole. Drill, assign the screw length and insert the screw.

If the plate position needs adjustment: remove all K-wires in the fragment to be adjusted, slightly loosen the cortical screw in the oblong hole, readjust the position of the plate and retighten the cortical screw.

Drill, assign the screw length and insert blue TriLock screws (A-5850.xx) starting with the screw holes next to the fracture for early stability.

The torque necessary to lock the screws is different depending on bone quality. In bone with low resistance (lateral clavicle) the torque required to lock a screw is lower than in bone with high resistance (shaft of the clavicle). In case of poor bone quality, a slight axial pressure may be necessary to achieve proper locking. After having reached the locking torque, do not further tighten the screw, otherwise the locking function cannot be guaranteed anymore.

Warning

If a TriLock^{PLUS} hole is used to compress the fracture, this hole should be used before placing any other TriLock screws on this side of the fracture line (see chapter "TriLock^{PLUS}").

Warning

If screws are used bicortically, a broad bone elevator placed under the clavicle while drilling may prevent overpenetration of the second cortex.

Repeat the steps above to fill the remaining screw holes and remove all K-wires.

Determine the combination of screws to be used for fixation. Cortical screws permit to pull a fragment to the plate. If a cortical screw is used to achieve appropriate plate and bone contact, it should be inserted before any locking screw is inserted into that fragment. Angular stable screws generally provide a higher stability of the construct, especially in case of a comminuted fracture or poor bone quality.

The multidirectionality of the locking ($\pm 15^\circ$) and non-locking screws allows to individually address each fragment. The superior and anterior midshaft plates feature screw holes at both plate ends that are preangulated. The superior lateral shaft plates have a preangulated hole on the medial plate end only. In superior plates, medial plate end holes are preangulated 15° towards medial whereas lateral plate end holes are preangulated 15° towards lateral. In anterior plates all plate end holes are preangulated towards medial.

Caution

Use intraoperative X-ray control to verify the length and position of the screws.

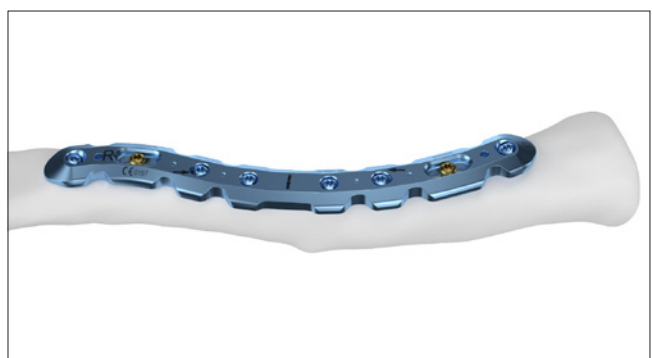
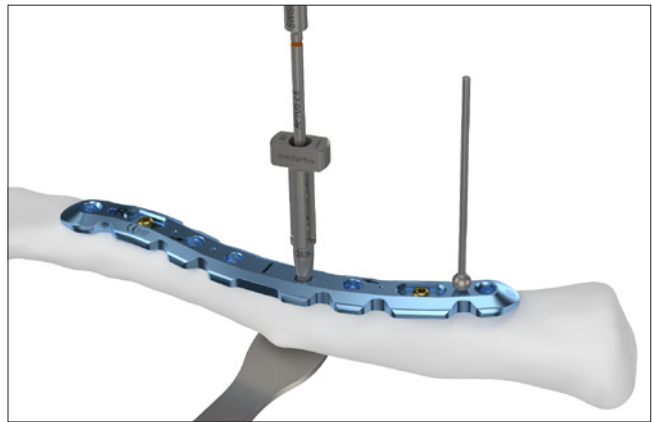

Superior Lateral Plates (A-4851.01–04)

1. Fixing the drill guide block

Position the drill guide block (A-2823.01 for left plates and A-2823.02 for right plates) on the lateral end of the plate (A-4851.01–04) so that the three positioning aids on its underside noticeably engage with the plate surface. Use the screwdriver (screwdriver blade A-2013 with handle A-2078) to finger tighten the screw integrated in the drill guide block until there is no play between the plate and the drill guide block. When the drill guide block is correctly mounted onto the plate, a uniform small gap is visible.

Warning

If the drill guide block is mounted onto the plate when the plate is already positioned on the bone, ensure that no soft tissue is trapped between the plate and the drill guide block and that the drill guide block is correctly aligned.



2. Positioning the plate

After reduction of the fracture, select the appropriate clavicle plate (A-4851.01–04) and position the plate over the fracture line. If required, bend the plate and the flaps with the bending irons (A-2091.01–02) to achieve an adequate fit to the individual form of the bone. The flaps should have close contact with the bone and can be placed under the delta fascia.

If the lateral flaps are not used, they can be removed using adequate cutting pliers for appropriate cutting.

For temporary plate fixation, 1.6 mm K-wires (A-5040.41, A-5042.41) or olive K-wires (A-5045.41/1) may be used. Alternatively, the plate can be held to the bone by placing the tip of the pointed reduction forceps into one of the dimples on the plate surface.

Caution

The placement of a K-wire through one of the most lateral K-wire holes may help preventing screw insertion into the acromioclavicular (AC) joint.



3. Fixation of the plate

Start the fixation with a golden cortical screw (A-5800.xx) in an oblong hole. Drill, assign the screw length and insert the screw.

If the plate position needs adjustment: remove all K-wires in the fragment to be adjusted, slightly loosen the cortical screw in the oblong hole, readjust the position of the plate and retighten the cortical screw.

Drill, assign the screw length and insert blue TriLock screws (A-5850.xx) starting with the screw holes next to the fracture for early stability.



The torque necessary to lock the screws is different depending on bone quality. In bone with low resistance (lateral clavicle) the torque required to lock a screw is lower than in bone with high resistance (shaft of the clavicle). In case of poor bone quality, a slight axial pressure may be necessary to achieve proper locking. After having reached the locking torque, do not further tighten the screw, otherwise the locking function cannot be guaranteed anymore.

Warning

If a TriLock^{PLUS} hole is used to compress the fracture, this hole should be used before placing any other locking screws on this side of the fracture line (see chapter "TriLock^{PLUS}").

Notice

The screw holes on the anterior flaps of the plate must not yet be filled.

These screw holes must only be used after the screw placement through the plate from superior.

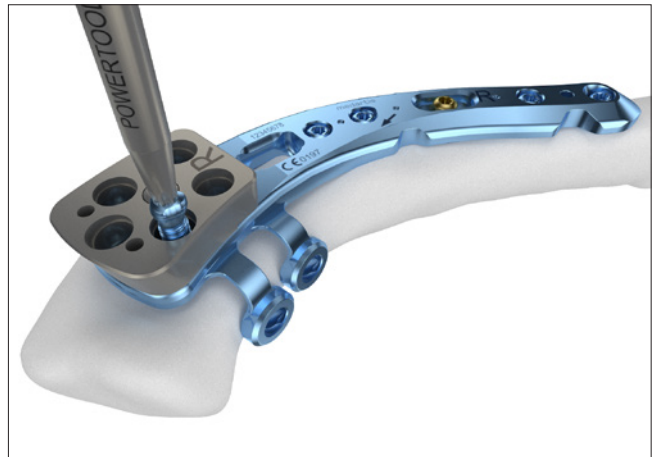

Warning

If screws are used bicortically, a broad bone elevator placed under the clavicle while drilling may prevent overpenetration of the second cortex.

Remove the drill guide block after all superior screw holes have been filled.

Repeat the steps above to fill the remaining screw holes and remove all K-wires.

The multidirectionality of the locking ($\pm 15^\circ$) and non-locking screws allows to individually address each fragment. The most medial screw hole in the superior lateral plates is preangulated 15° towards medial.

4. Inserting AP screws

In case of distal fractures, inserting bicortical screws from anterior to posterior may improve overall stability of the construct.

Notice

If the lateral plate slot is used for suture or cortical screw fixation, insert the medial anteroposterior (AP) screw away from the slot to prevent possible collisions.

Caution

The multidirectionality of the locking ($\pm 15^\circ$) and non-locking screws helps to avoid screw collisions and prevents screw insertion into the acromioclavicular (AC) joint. Use intraoperative X-ray control to verify the screw lengths and that no screws are placed in the AC joint.

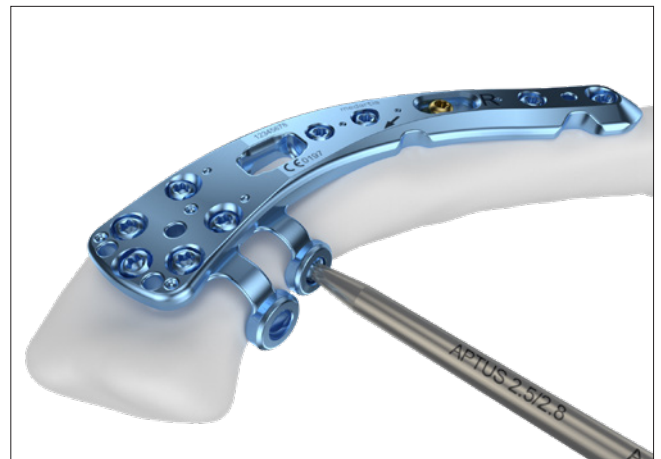

Suture Fixation on Superior Lateral Plates (A-4851.01–04, A-4899.01)

Notice

The superior lateral plates are designed to hold sutures used to treat coracoclavicular (CC) ligament injuries associated with lateral clavicle fractures. After the fixation of the plate (see chapter “Superior Lateral Plates”), a suture fixation insert (A-4899.01) can be placed into the plate slot to secure sutures to the plate.

As an alternative option, an insert for cortical screw fixation (A-4899.02) can be placed into the plate slot. See chapter “Cortical Screw Fixation on Superior Lateral Plates”.

1. Drilling

Drill a central core hole through the plate slot using the drill guide (A-2820) and the twist drill \varnothing 2.35 mm (A-3832, one colored ring). This hole should be drilled in the direction of the suture placement.

Warning

In case of bicortical drilling, a broad bone elevator placed under the clavicle while drilling may prevent overpenetration of the second cortex.

2. Inserting the suture retriever

Push the guide for the suture retriever (A-2821) through the drilled hole, insert the suture retriever (A-2822) into the guide and turn its handle until the curved tip of the instrument points towards you.

Caution

Ensure not to bend the guide for the suture retriever. The set does not include suture material or a coracoid passer.

3. Passing the suture through the plate

Thread one suture end through the loop and pull the suture retriever up through the guide until the suture end has passed through the guide. Hold the guide in place with the other hand while doing so. Unthread the suture end from the suture retriever.

Insert the suture retriever into the guide one more time and repeat step 3 to retrieve the second end of the suture while holding the first suture in place.

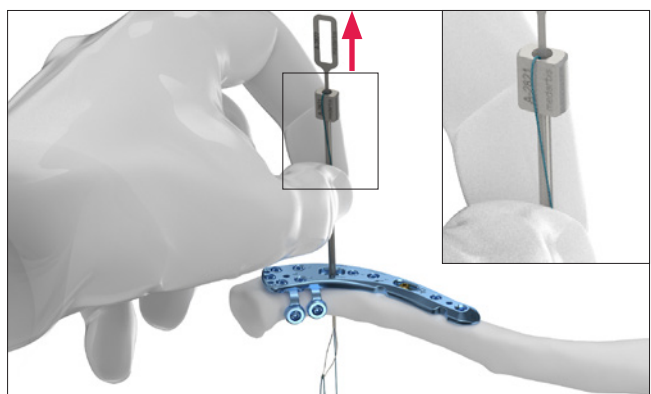
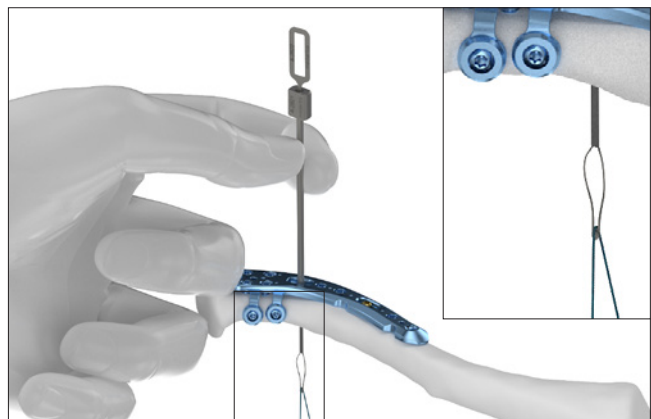

Remove the suture retriever guide.

Caution

The use of suture No. 2 or No. 5 is recommended. To pass sutures thicker than recommended, pull the guide (inner diameter 2.0 mm) up together with the suture retriever when passing the second suture end through the plate.

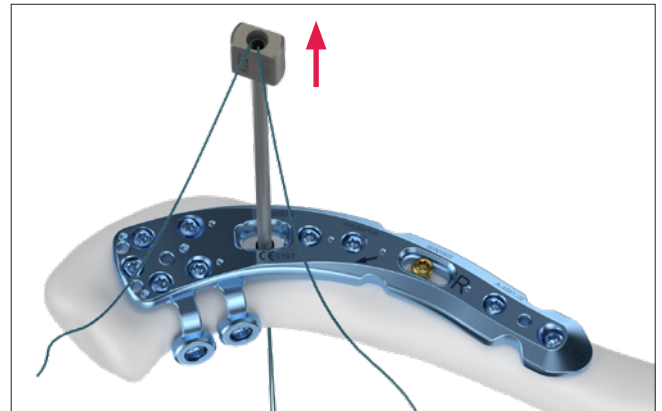

4. Applying the insert for suture fixation

Hold the insert for suture fixation (A-4899.01) with the label "TOP" on the handle and the flat surface of the insert facing up. Pass the suture strands through the insert from inferior to superior.

Notice

Ensure that the sutures are not twisted prior to seating the insert into the plate.

Slide the insert down into the plate slot and gently snap off the handle.

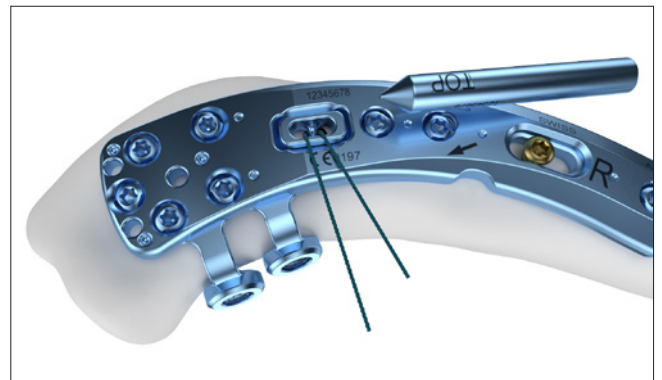
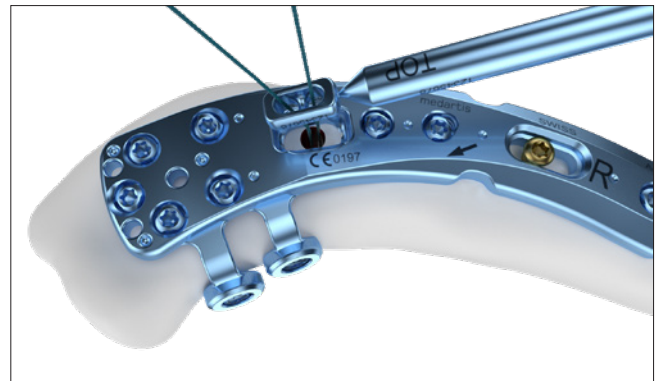

5. Tying the suture

The insert lies in the plate and serves as a counter bearing for the knot of the suture. Pull the suture to get the proper tension and reduction, then secure the suture with a surgeon's knot over the bar and at least three additional reversing half hitches.

Warning

Ensure the insert sits flush with the top surface of the plate before tying the second knot.

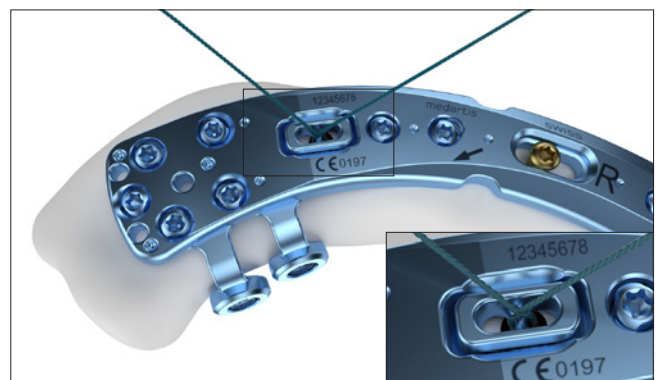

Cortical Screw Fixation on Superior Lateral Plates

(A-4851.01-04, A-4899.02)

Warning

If a suture fixation technique is not required for the treated fracture, a cortical screw can be placed into the respective plate slot by using the insert for cortical screw fixation (A-4899.02).

1. Placing the insert for cortical screw fixation

Hold the insert for cortical screw fixation (A-4899.02) with the label "TOP" on the handle and the flat surface of the insert facing up. Place the insert into the plate slot and gently snap off the handle.

Notice

Hold the insert in place with your finger to prevent it from falling out of the plate slot.

2. Drilling

Drill a core hole through the insert for cortical screw fixation using the drill guide (A-2820) and the core hole drill \varnothing 2.35 mm (A-3832, one colored ring).

Notice

Make sure the insert sits flush with the top surface of the plate when drilling.

Caution

If screws are used bicortically, a broad bone elevator placed under the clavicle while drilling may prevent overpenetration of the second cortex.

3. Inserting the cortical screw

Assign the screw length and insert the corresponding cortical screw (A-5800.xx).

Warning

Make sure the insert sits flush with the top surface of the plate when inserting the screw.

Caution

Use intraoperative X-ray control to verify the length and position of the screw.

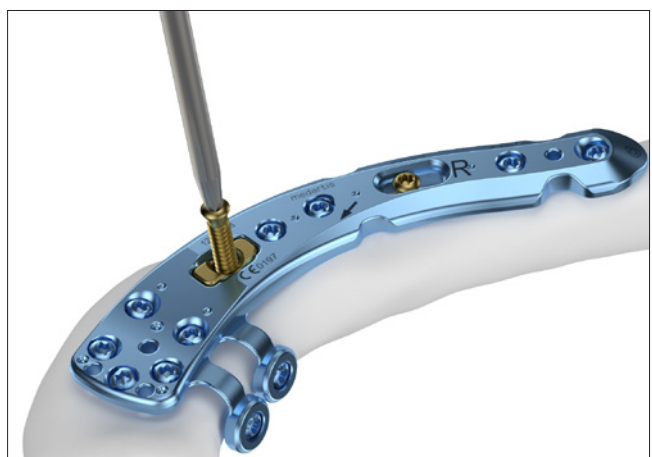
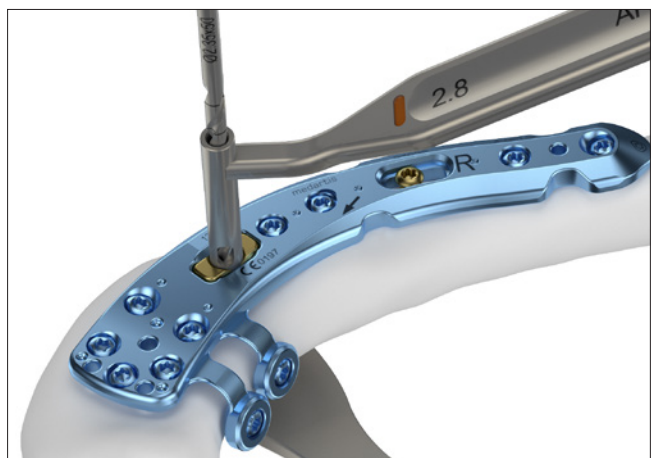

Explantation

Explantation of Clavicle Plates

1. Removing the screws

Unlock all screws and remove them.

The order in which the screws are removed is not relevant except when explanting a superior lateral plate (A-4951.01-04), where the screws in the anterior flaps should be removed first.

In case the plate sticks to the bone, use a periosteal elevator to carefully lift and detach it from the bone.

Caution

When removing the screws, ensure that any bone ingrowth in the screw head has been removed, that the screwdriver/screw head connection is aligned in axial direction, and that a sufficient axial force is used between blade and screw.

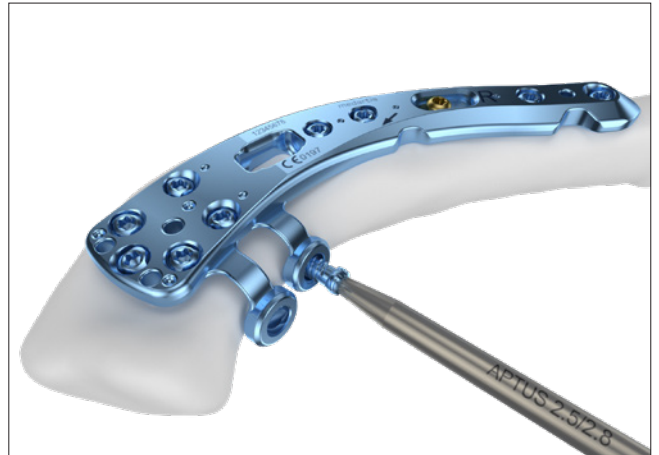

Explantation of Insert for Suture Fixation (A-4899.01)

1. Removing the suture

Remove the suture.

Caution

Hold the insert for suture fixation (A-4899.01) in place with the help of forceps while removing the suture.

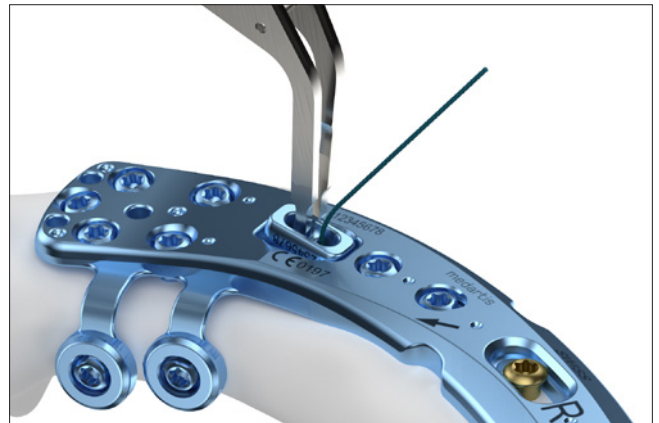

2. Removing the insert for suture fixation

Take the insert out of the plate slot using forceps.



Explantation of Screw and Insert for Cortical Screw Fixation

(A-5800.xx, A-4899.02)

1. Removing the cortical screw

Remove the cortical screw (A-5800.xx) from the insert (A-4899.02) with the screwdriver (screwdriver blade A-2013 with handle A-2078).

Caution

Hold the insert in place with the help of forceps while removing the screw.

Caution

When removing the screws, ensure that any bone ingrowth in the screw head has been removed, that the screwdriver/screw head connection is aligned in axial direction, and that a sufficient axial force is used between blade and screw.

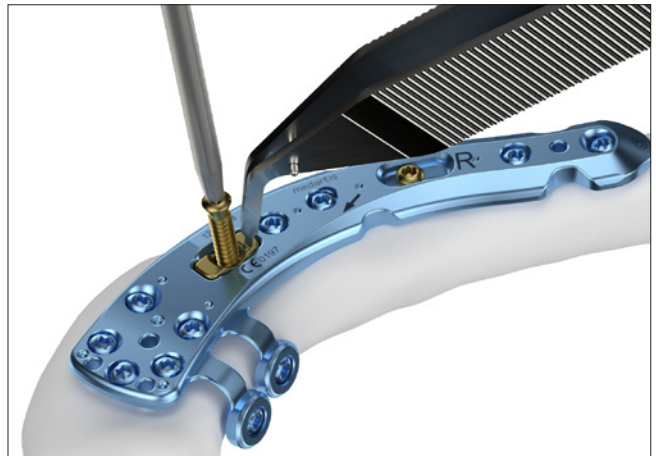

2. Removing the insert for cortical screw fixation

Take the insert out of the plate slot using forceps.

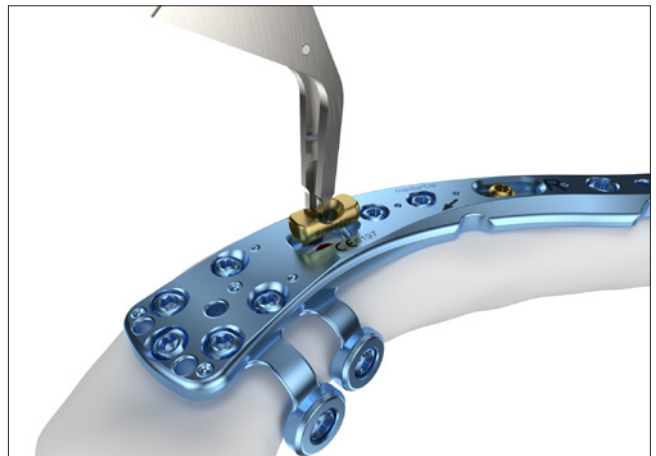

TriLock Locking Technology

Correct Application of the TriLock Locking Technology

The screw is inserted through the plate hole into a predrilled canal in the bone. An increase of the tightening torque will be felt as soon as the screw head gets in contact with the plate surface.

This indicates the start of the "Insertion Phase" as the screw head starts entering the locking zone of the plate (section "A" in the diagram). Afterwards, a drop of the tightening torque occurs (section "B" in the diagram). Finally the actual locking

is initiated (section "C" in the diagram) as a friction connection is established between screw and plate when tightening firmly.

The torque applied during fastening of the screw is decisive for the quality of the locking as described in section "C" of the diagram.

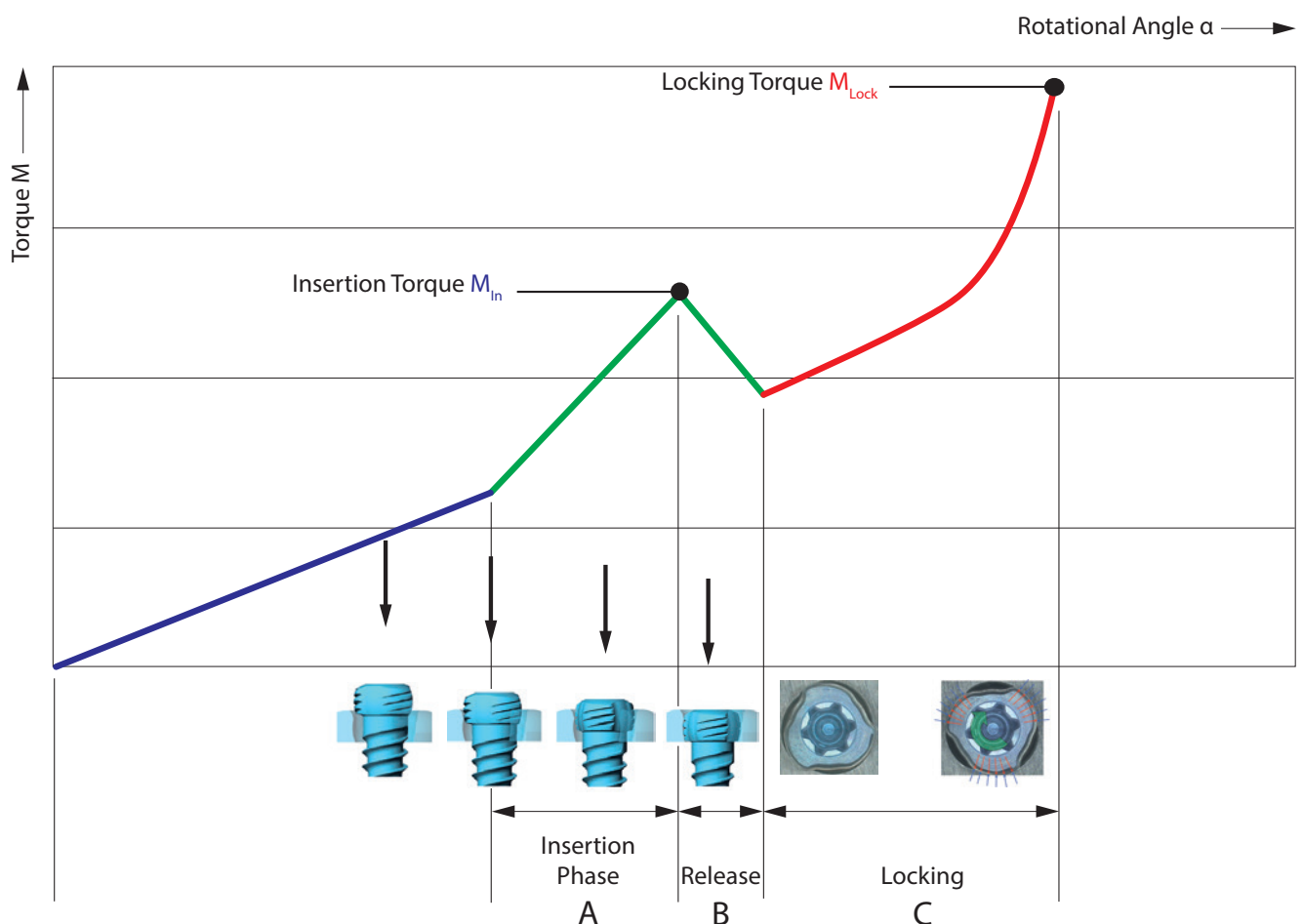

Correct Locking ($\pm 15^\circ$) of the TriLock Screws in the APTUS Clavicle System 2.8

Correct locking occurs only when the screw head is locked flush with the locking contour (fig. 1 and 3).

However, if there is still a noticeable protrusion (fig. 2 and 4), the screw head has not completely reached the locking position. In this case, the screw has to be retightened to obtain full penetration and proper locking. In case of poor bone quality,

a slight axial pressure may be necessary to achieve proper locking.

After having reached the locking torque (M_{Lock}), do not further tighten the screw, otherwise the locking function cannot be guaranteed anymore.

Correct: LOCKED



Figure 1

Incorrect: UNLOCKED



Figure 2

Correct: LOCKED

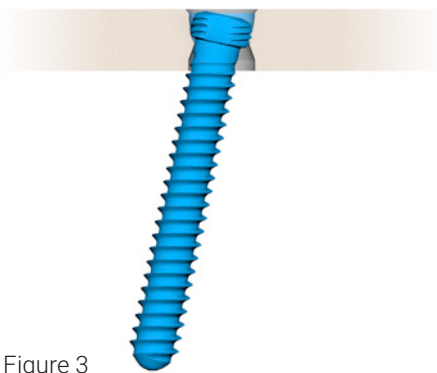

Figure 3

Incorrect: UNLOCKED

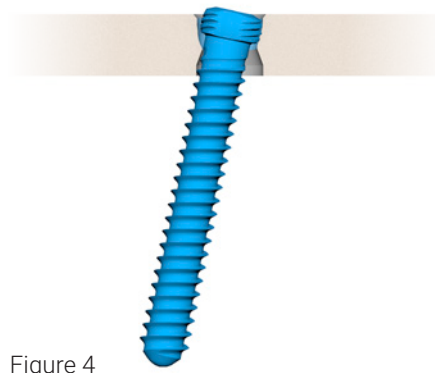
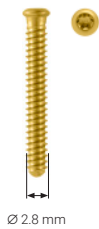

Figure 4

Implants, Instruments and Containers

2.8 Cortical Screws, HexaDrive 7

Material: Titanium alloy (ASTM F136)



Length	Art. No.	STERILE	Pieces / Pkg	Art. No.	Pieces / Pkg
8 mm	A-5800.08/1	A-5800.08/1S	1	A-5800.08	5
10 mm	A-5800.10/1	A-5800.10/1S	1	A-5800.10	5
12 mm	A-5800.12/1	A-5800.12/1S	1	A-5800.12	5
14 mm	A-5800.14/1	A-5800.14/1S	1	A-5800.14	5
16 mm	A-5800.16/1	A-5800.16/1S	1	A-5800.16	5
18 mm	A-5800.18/1	A-5800.18/1S	1	A-5800.18	5
20 mm	A-5800.20/1	A-5800.20/1S	1	A-5800.20	5
22 mm	A-5800.22/1	A-5800.22/1S	1	A-5800.22	5
24 mm	A-5800.24/1	A-5800.24/1S	1	A-5800.24	5
26 mm	A-5800.26/1	A-5800.26/1S	1	A-5800.26	5
28 mm	A-5800.28/1	A-5800.28/1S	1	A-5800.28	5
30 mm	A-5800.30/1	A-5800.30/1S	1	A-5800.30	5
32 mm	A-5800.32/1	A-5800.32/1S	1	A-5800.32	5
34 mm	A-5800.34/1	A-5800.34/1S	1	A-5800.34	5
36 mm	A-5800.36/1	A-5800.36/1S	1	A-5800.36	5

2.8 TriLock Screws, HexaDrive 7

Material: Titanium alloy (ASTM F136)

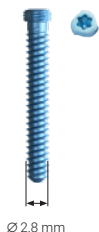

Length	Art. No.	STERILE	Pieces / Pkg	Art. No.	Pieces / Pkg
8 mm	A-5850.08/1	A-5850.08/1S	1	A-5850.08	5
10 mm	A-5850.10/1	A-5850.10/1S	1	A-5850.10	5
12 mm	A-5850.12/1	A-5850.12/1S	1	A-5850.12	5
14 mm	A-5850.14/1	A-5850.14/1S	1	A-5850.14	5
16 mm	A-5850.16/1	A-5850.16/1S	1	A-5850.16	5
18 mm	A-5850.18/1	A-5850.18/1S	1	A-5850.18	5
20 mm	A-5850.20/1	A-5850.20/1S	1	A-5850.20	5
22 mm	A-5850.22/1	A-5850.22/1S	1	A-5850.22	5
24 mm	A-5850.24/1	A-5850.24/1S	1	A-5850.24	5
26 mm	A-5850.26/1	A-5850.26/1S	1	A-5850.26	5
28 mm	A-5850.28/1	A-5850.28/1S	1	A-5850.28	5
30 mm	A-5850.30/1	A-5850.30/1S	1	A-5850.30	5
32 mm	A-5850.32/1	A-5850.32/1S	1	A-5850.32	5
34 mm	A-5850.34/1	A-5850.34/1S	1	A-5850.34	5
36 mm	A-5850.36/1	A-5850.36/1S	1	A-5850.36	5

Drill Guide Blocks Clavicle (incl. Screw)

Material: Stainless steel



A-2823.01



A-2823.02

Art. No.	Description	Pieces / Pkg
A-2823.01	superior lateral	1
A-2823.02	superior lateral	1
A-2823.03	screw for drill guide block	1

Inserts for Superior Lateral Plates Clavicle

Material: Titanium alloy (ASTM F136)

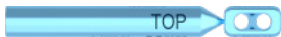

A-4899.01

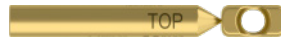

A-4899.02

Art. No.	STERILE	Description	Pieces / Pkg
A-4899.01	A-4899.01S	insert for suture fixation	1
A-4899.02	A-4899.02S	insert for cortical screw fixation	1

2.8 TriLock Clavicle Plates, Superior Lateral

Material: Titanium alloy (ASTM F136)
Plate thickness: 2.2 – 3.4 mm

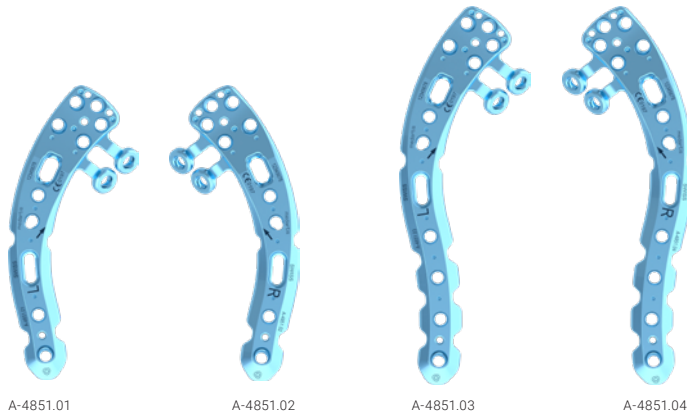

Art. No.	STERILE	Template	Description	Holes	Length	Pieces / Pkg
A-4851.01	A-4851.01S	A-4851.01TP	left	12	79 mm	1
A-4851.02	A-4851.02S	A-4851.02TP	right	12	79 mm	1
A-4851.03	A-4851.03S	A-4851.03TP	left	14	100 mm	1
A-4851.04	A-4851.04S	A-4851.04TP	right	14	100 mm	1

2.8 TriLock Clavicle Plates, Superior, Lateral Shaft

Material: Titanium alloy (ASTM F136)
Plate thickness: 2.2 – 3.4 mm

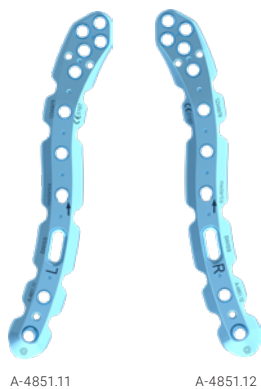

Art. No.	STERILE	Template	Description	Holes	Length	Pieces / Pkg
A-4851.11	A-4851.11S	A-4851.11TP	left	11	94 mm	1
A-4851.12	A-4851.12S	A-4851.12TP	right	11	94 mm	1

2.8 TriLock Clavicle Plates, Superior Midshaft

Material: Titanium alloy (ASTM F136)
Plate thickness: 3.4 mm

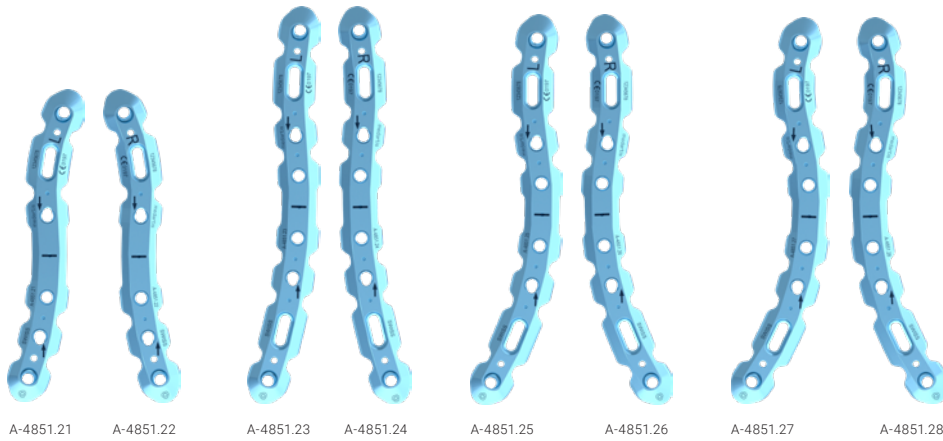

Art. No.	STERILE	Template	Description	Holes	Length	Pieces / Pkg
A-4851.21	A-4851.21S	A-4851.21TP	left	6	84 mm	1
A-4851.22	A-4851.22S	A-4851.22TP	right	6	84 mm	1
A-4851.23	A-4851.23S	A-4851.23TP	left, low bend	8	106 mm	1
A-4851.24	A-4851.24S	A-4851.24TP	right, low bend	8	106 mm	1
A-4851.25	A-4851.25S	A-4851.25TP	left, medium bend	8	104 mm	1
A-4851.26	A-4851.26S	A-4851.26TP	right, medium bend	8	104 mm	1
A-4851.27	A-4851.27S	A-4851.27TP	left, high bend	8	103 mm	1
A-4851.28	A-4851.28S	A-4851.28TP	right, high bend	8	103 mm	1

2.8 TriLock Clavicle Plates, Superior Midshaft

Material: Titanium alloy (ASTM F136)
Plate thickness: 3.4 mm

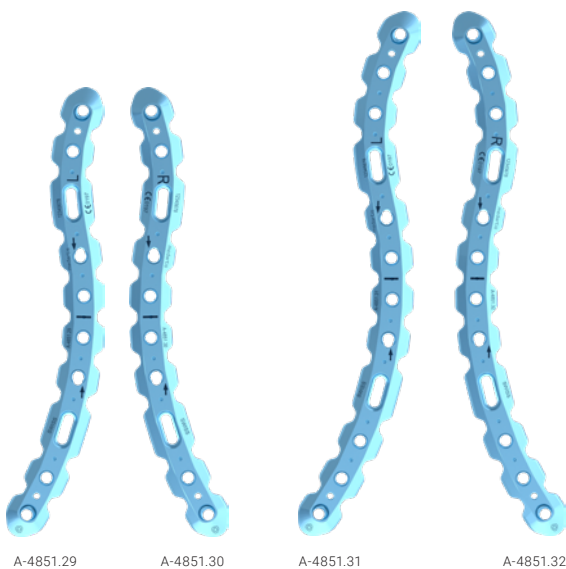

Art. No.	STERILE	Template	Description	Holes	Length	Pieces / Pkg
A-4851.29	A-4851.29S	A-4851.29TP	left	10	121 mm	1
A-4851.30	A-4851.30S	A-4851.30TP	right	10	121 mm	1
A-4851.31	A-4851.31S	A-4851.31TP	left	12	141 mm	1
A-4851.32	A-4851.32S	A-4851.32TP	right	12	141 mm	1

2.8 TriLock Clavicle Plates, Anterior Midshaft

Material: Titanium alloy (ASTM F136)
Plate thickness: 3.4 mm

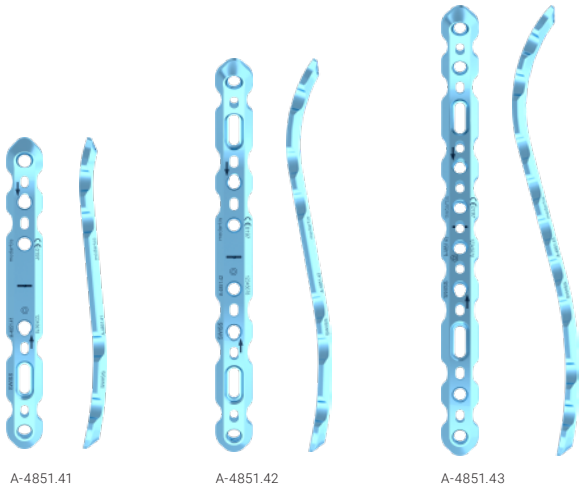

Art. No.	STERILE	Template	Holes	Length	Pieces / Pkg
A-4851.41	A-4851.41S	A-4851.41TP	6	82 mm	1
A-4851.42	A-4851.42S	A-4851.42TP	8	104 mm	1
A-4851.43	A-4851.43S	A-4851.43TP	10	119 mm	1

2.8 TriLock Clavicle Plate, Anterior Lateral

Material: Titanium alloy (ASTM F136)
Plate thickness: 3.4 mm



Art. No.	STERILE	Template	Holes	Length	Pieces / Pkg
A-4851.51	A-4851.51S	A-4851.51TP	6	80 mm	1

Guide Suture Retriever



Art. No.	Length	Pieces / Pkg
A-2821	90 mm	1

Suture Retriever



Art. No.	Length	Pieces / Pkg
A-2822	139 mm	1

Plate Bending Irons Clavicle



Art. No.	Description	Length	Pieces / Pkg
A-2091.01	1/2	218 mm	1
A-2091.02	2/2	218 mm	1

Twist Drill Ø2.35 mm



Art. No.	STERILE	System Size	Stop	Length	Shaft End	Pieces / Pkg
A-3832	A-3832S	2.8	50 mm	101 mm	AO Quick Coupling	1

Twist Drill Ø2.9 mm (for Gliding Hole)



Art. No.	STERILE	System Size	Stop	Length	Shaft End	Pieces / Pkg
A-3834	A-3834S	2.8	10 mm	61 mm	AO Quick Coupling	1

Countersink for Cortical Screws



Art. No.	STERILE	System Size	Stop	Length	Shaft End	Pieces / Pkg
A-3835	A-3835S	for 2.8 cortical screws	3.7 mm	45 mm	AO Quick Coupling	1

Tap Ø2.8



Art. No.	Length	Thread Length	Shaft End	Pieces / Pkg
A-3839	110 mm	75 mm	AO Quick Coupling	1

K-Wires, Stainless Steel



Art. No.	STERILE	∅	Description	Length	Pieces / Pkg
A-5040.41		1.6 mm	trocar	150 mm	10
	A-5040.41/2S	1.6 mm	trocar	150 mm	2
A-5042.41		1.6 mm	lancet	150 mm	10
	A-5042.41/2S	1.6 mm	lancet	150 mm	2

Olive K-Wires, Stainless Steel

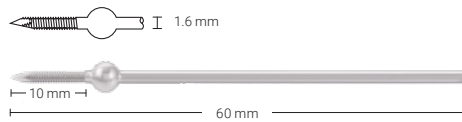

Length	Thread Length	∅	Art. No.	Pieces / Pkg	Art. No.	Pieces / Pkg	STERILE	Pieces / Pkg
60 mm	10 mm	1.6 mm	A-5045.41/1	1	A-5045.41/4	4	A-5045.41/2S	2

Drill Guides



Art. No.	System Size	Description	Length	Pieces / Pkg
A-2820	2.8	for core and gliding hole	146 mm	1
A-2827	2.5 / 2.8	TriLock ^{PLUS} , 2-end	146 mm	1

Drill Sleeve



Art. No.	System Size	Description	Length	Pieces / Pkg
A-2826	2.5 / 2.8	self-holding	34 mm	1

Depth Gauge



Art. No.	System Size	Length	Pieces / Pkg
A-2031	2.0 – 2.8	189 mm	1

Handle with Quick Connector



Art. No.	Length	For Shaft End	Pieces / Pkg
A-2078	135 mm	AO Quick Coupling	1

Screwdriver Blade, Self-Holding



HD7

Art. No.	System Size	Interface	Length	Shaft End	Pieces / Pkg
A-2013	2.5 / 2.8	HD7	75 mm	AO Quick Coupling	1

Reduction Forceps



Art. No.	Description	Length	Pieces / Pkg
A-7022	fine ratchet	130 mm	1

Bone Holding Forceps



Art. No.	Description	Length	Pieces / Pkg
A-7023	fine ratchet	140 mm	1

Wound Retractor



Art. No.	Description	Length	Pieces / Pkg
A-7024	self-retaining	130 mm	1

Bone Elevators Hohmann



A-7006



A-7025

Art. No.	Description	Width	Length	Pieces / Pkg
A-7006	mini	8 mm	160 mm	1
A-7025		15 mm	160 mm	1

Cases, Trays

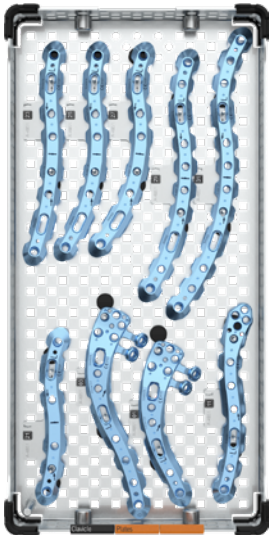

A-6606.001
(excl. implants)

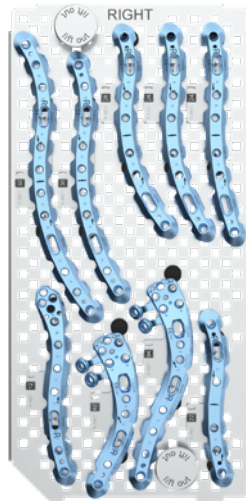

A-6606.007
(excl. implants)

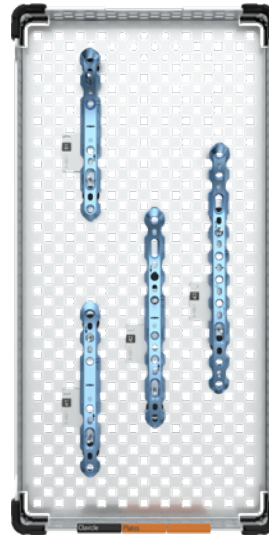

A-6606.002
(excl. implants)

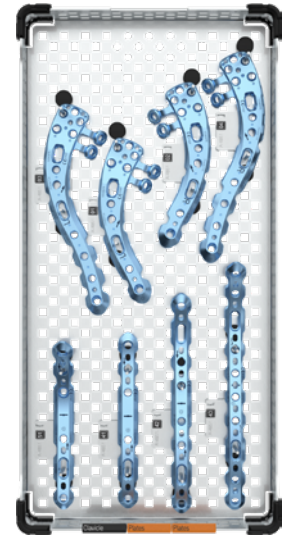

A-6606.003
(excl. implants)

Art. No.	Description	Width	Pieces / Pkg
A-6606.001	implant case APTUS clavicle plates 2.8, superior left	120 mm	1
A-6606.002	implant case APTUS clavicle plates 2.8, anterior	120 mm	1
A-6606.003	implant case APTUS clavicle plates 2.8, anterior and superior lateral	120 mm	1
A-6606.007	plate tray APTUS clavicle 2.8, superior right	120 mm	1
M-6726	lid for implant and instrument case 120 × 240 mm	120 mm	1

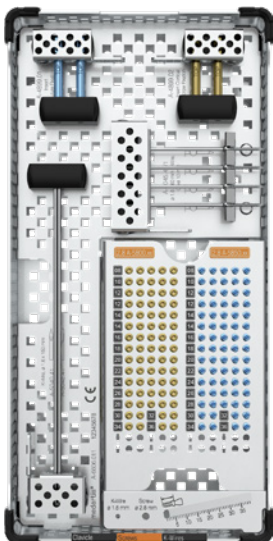

A-6606.010 containing A-6606.011 and A-6606.012
(excl. implants and K-wires)

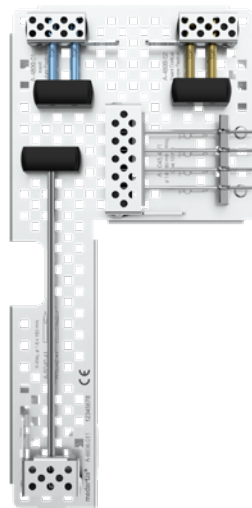

A-6606.011
(excl. implants and K-wires)

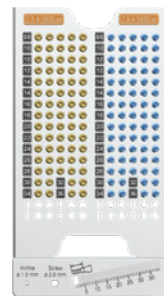

A-6606.012
(excl. implants)

Art. No.	Description	Width	Pieces / Pkg
A-6606.010	implant/instrument case APTUS clavicle 2.8	120 mm	1
A-6606.011	implant/instrument tray APTUS clavicle 2.8 for inserts and K-wires	120 mm	1
A-6606.012	screw tray APTUS clavicle 2.8	120 mm	1
M-6726	lid for implant and instrument case 120 × 240 mm	120 mm	1

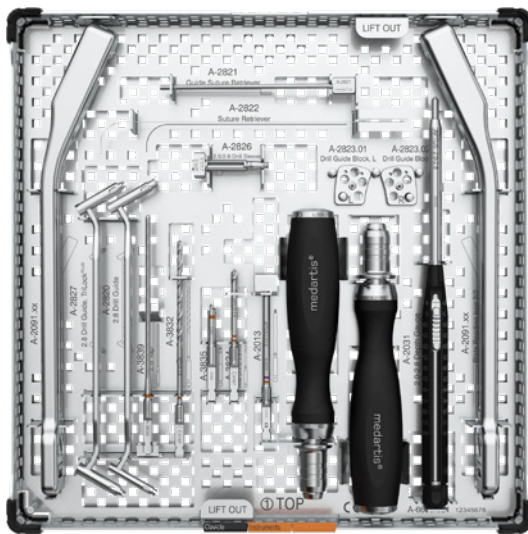

A-6606.020 containing A-6606.021
(excl. instruments)

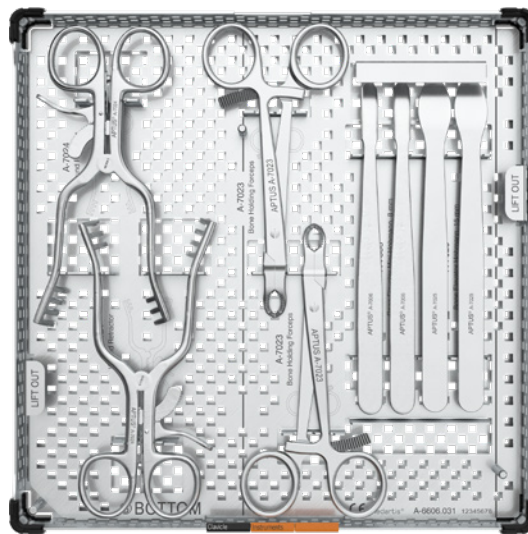

A-6606.030 containing A-6606.031
(excl. instruments)

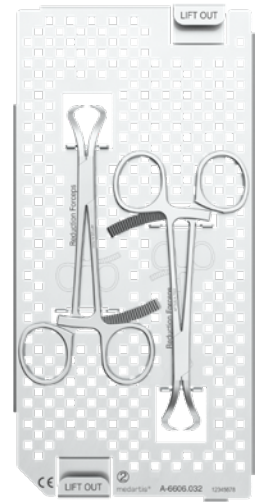

A-6606.032
(excl. instruments)

Art. No.	Description	Width	Pieces / Pkg
A-6606.020	system instrument case APTUS clavicle 2.8	240 mm	1
A-6606.021	system instrument tray APTUS clavicle	240 mm	1
A-6606.030	reduction instrument case APTUS clavicle 2.8	240 mm	1
A-6606.031	reduction instrument tray APTUS clavicle "3", lower	240 mm	1
A-6606.032	reduction instrument tray APTUS clavicle "2", upper	240 mm	1
M-6727	lid for implant and instrument case 240 x 240 mm	240 mm	1

Art. No.	Description	Width	Pieces / Pkg
A-6606.050	template case APTUS clavicle 2.8, superior left	120 mm	1
A-6606.051	template case APTUS clavicle 2.8, anterior	120 mm	1
A-6606.052	template case APTUS clavicle 2.8, anterior and superior lateral	120 mm	1
A-6606.056	template tray APTUS clavicle 2.8, superior right	120 mm	1
M-6726	lid for implant and instrument case 120 x 240 mm	120 mm	1

Storage and Transportation*

Art. No.	Description	Dimensions (L x W x H)	Pieces / Pkg
A-6610.40*	storage container for instruments and 2 plate cases	265 x 257 x 177 mm	1
A-6610.41*	storage container for instruments and 1 plate case	265 x 257 x 177 mm	1
A-6611*	lid for A-6610.xx	273 x 260 mm	1
M-6710	holding rack for implant and instrument cases, for case 240 x 240 mm	252 x 243 x 143 mm	1
M-6720	holding rack for implant and instrument cases, for case 240 x 240 mm	252 x 243 x 245 mm	1

*Not available in all countries

Articles available on request

A-5040.41/1

A-5042.41/1

R_SHOULDER-01010101_v0 / © 2021-08, Medartis AG, Switzerland. All technical data subject to alteration.

MANUFACTURER & HEADQUARTERS

Medartis AG | Hochbergerstrasse 60E | 4057 Basel / Switzerland

P +41 61 633 34 34 | F +41 61 633 34 00 | www.medartis.com

SUBSIDIARIES

Australia | Austria | Brazil | China | France | Germany | Japan | Mexico | New Zealand | Poland | Spain | UK | USA

For detailed information regarding our subsidiaries and distributors, please visit www.medartis.com



Disclaimer: This information is intended to demonstrate the Medartis portfolio of medical devices. A surgeon must always rely on her or his own professional clinical judgement when deciding whether to use a particular product when treating a particular patient. Medartis is not giving any medical advice. The devices may not be available in all countries due to registration and / or medical practices. For further questions, please contact your Medartis representative (www.medartis.com). This information contains CE-marked products.
For US only: Federal law restricts this device to sale by or on the order of a physician.