

medartis

PRECISION IN FIXATION

SURGICAL TECHNIQUE

# Elbow System 2.0, 2.8

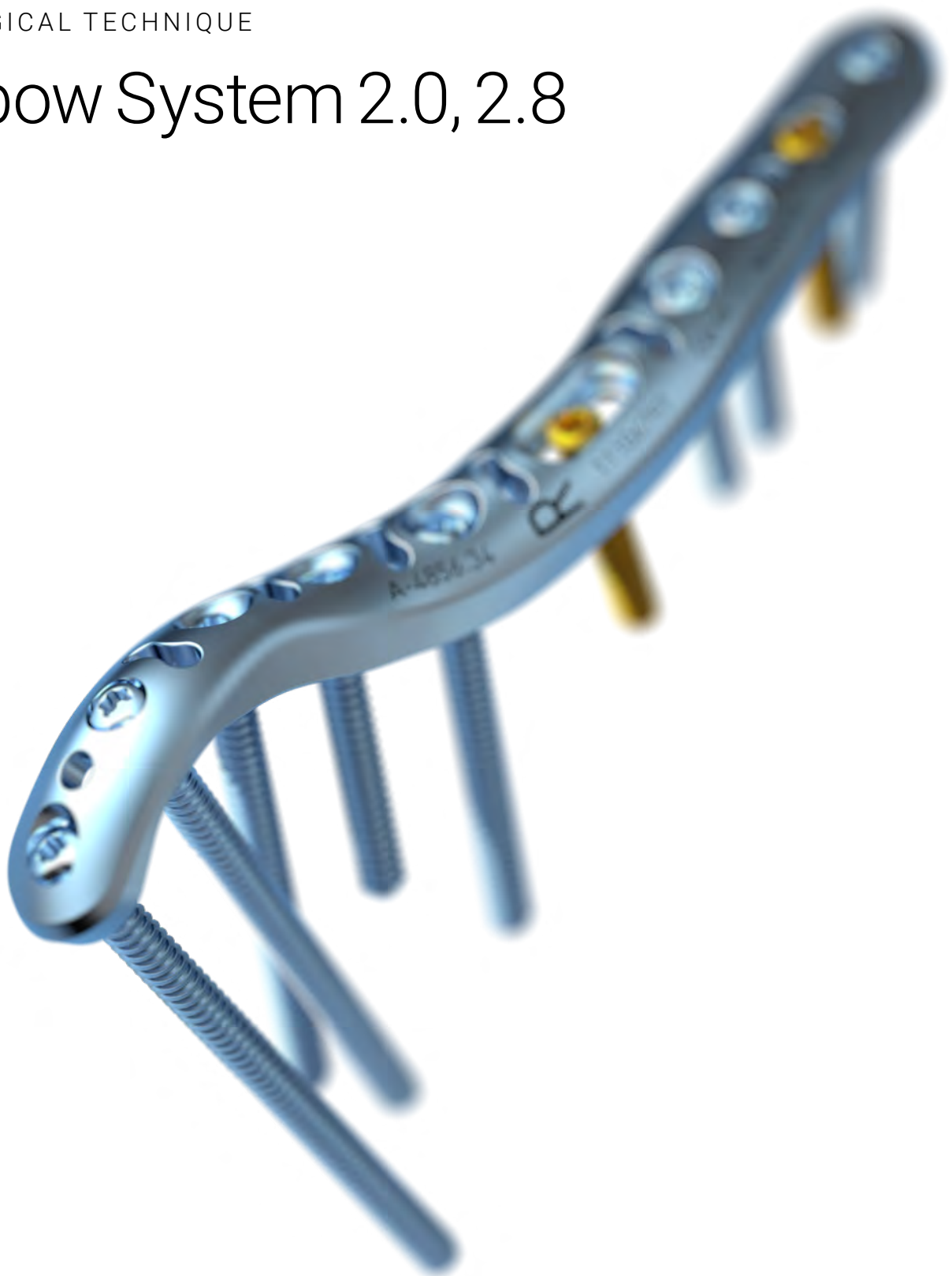

**APTUS** Elbow

# Contents

3	Introduction
	Product Materials
	Indications
	Contraindications
	Specific Complications
	Color Coding
	Symbols
4	System Overview
5	Treatment Concept
7	Instrument Application
	General Instrument Application
	Sizing Templates
8	Bending
10	Plate Bending Iron Elbow
11	Drilling
12	Assigning the Screw Length
13	Thread Preparation with the Tap
14	Screw Pick-Up
15	Specific Instrument Application
15	Aiming Device for Distal Humerus Plates
18	Surgical Techniques
18	General Surgical Techniques
18	Lag Screw Techniques
19	Lag Screw Technique Using Cortical Screws
19	Lag Screw Technique Using Lag Screws
20	Use of the compression hole
21	Specific Surgical Techniques
21	2.0 Radial Head Plates
23	2.0 Coronoid Plates
25	2.8 Olecranon Tension Plate
28	2.8 Olecranon Double Plates
31	Distal Humerus Plates
35	Explantation
	Explication of Elbow Plates
36	TriLock Locking Technology
36	Correct Application of the TriLock Locking Technology
37	Correct Locking ( $\pm 15^\circ$ ) of the TriLock Screws in the Plate
38	Implants, Instruments and Containers

# Introduction

## Product Materials

Product	Material
Plates	Pure titanium
Screws	Titanium alloy
Washers	Titanium alloy
K-wires	Stainless steel
Instruments	Stainless steel, PEEK, aluminum, Nitinol, silicone or titanium
Containers	Stainless steel, aluminum, PEEK, polyphenylsulfone, polyurethane, silicone

## Indications

### APTUS Elbow

Fractures and osteotomies of the bones of the elbow

- Proximal radius plates
  - fractures and osteotomies of the proximal radius
- Distal humerus plates
  - fractures, osteotomies and non-unions of the distal humerus
- Proximal ulna plates
  - fractures and osteotomies of the proximal ulna

## Contraindications

- Preexisting or suspected infection at or near the implantation site
- Known allergies and/or hypersensitivity to implant materials
- Inferior or insufficient bone quality to securely anchor the implant
- Patients who are incapacitated and/or uncooperative during the treatment phase
- Growth plates are not to be blocked with plates and screws

## Specific Complications

Specific complications that may be associated with the fixation of proximal ulna fractures include:

- early osteoarthritis

## Color Coding

System Size	Color Code
2.0	Blue
2.8	Orange

### Plates and Screws

Special implant plates and screws have their own color:

Implant plates blue	TriLock plates (locking)
Implant screws gold	Cortical screws (fixation)
Implant screws blue	TriLock screws (locking)

## Possible Combination of Plates and Screws

Plates and screws can be combined within one system size:

### 2.0 TriLock Plates

- 2.0 Cortical Screws, HexaDrive 6
- 2.0 TriLock Screws, HexaDrive 6
- 2.3 Cortical Screws, HexaDrive 6

### 2.8 TriLock Plates

- 2.8 Cortical Screws, HexaDrive 7
- 2.8 TriLock Screws, HexaDrive 7
- 2.8 Lag Screws, HexaDrive 7

## Symbols



HexaDrive



TriLock screw hole on sizing templates



# System Overview

The plates of the APTUS Elbow System 2.0, 2.8 are available in different designs and various plate lengths. For the complete implant portfolio, please refer to chapter "Implants, Instruments and Containers".

## 2.0 Radial Head Plates



A-4656.68  
Rim plate



A-4656.69  
Buttress plate



A-4656.80/81  
Left & Right

## 2.8 Olecranon Tension Plate



A-4856.01  
Tension plate

## 2.8 Distal Humerus Plates



A-4856.29-34  
Medial plates  
Left & Right



A-4856.39-44  
Lateral plates  
Left & Right



A-4856.49-54  
Posterolateral plates  
Left & Right

## 2.8 Olecranon Double Plates



A-4856.12/15  
Straight plates









A-4856.10/13  
Curved plates  
Right





A-4856.11/14  
Curved plates  
Left

# Treatment Concept

The table below lists typical clinical findings which can be treated with the implants of the APTUS Elbow System 2.0, 2.8.

Radial Head				
				
Fracture type	Complex and/or comminuted fractures of the radial head requiring subchondral support.	Osteotomies and fractures in the neck region of the radial head, particularly impacted fractures requiring buttressing. This plate shape allows a combination with isolated headless compression screws outside the plate for additional subchondral support.		
Plate type recommended	2.0 Radial Head Rim Plate A-4656.68	2.0 Radial Head Buttress Plate A-4656.69		
Proximal Ulna				
				
Fracture type	Fractures of the coronoid in which internal fixation with a plate is indicated.  Buttressing and fixation of the sublime tubercle.	Fractures and osteotomies of the proximal ulna with interfragmentary support.	Complex distal olecranon fractures without interfragmentary support.	Complex proximal olecranon fractures without interfragmentary support.
Plate type recommended	2.0 Coronoid Plates A-4656.80/81	2.8 Olecranon Tension Plate A-4856.01	2.8 Straight Double Plates A-4856.12/15	2.8 Curved Double Plates A-4856.10/11/13/14

Distal Humerus		
Examples for plate combinations	180° configuration: Combination of a medial (A-4856.29-34) and a lateral (A-4856.39-44) 2.8 Distal Humerus Plate	90° configuration: Combination of a medial (A-4856.29-34) and a posterolateral (A-4856.49-54) 2.8 Distal Humerus Plate
		

Per AO/OTA classification, typical clinical findings in the distal humerus can be treated with the APTUS distal humerus plates as suggested in the table below.

AO/OTA Classification	Medial Plate	Lateral Plate	Posterolateral Plate	180° Configuration	90° Configuration
13A2.2					
13A2.3					
13A3.1					
13A3.2					
13B1.1					
13B1.2					
13B1.3					
13B2.1					
13B2.3					
13B3.3					
13C1					
13C2					
13C3					

Primary recommendation  
 Possible

The above-mentioned information is a recommendation only. The operating surgeon is solely responsible for the choice of the suitable implant for the specific case.

# Instrument Application

## General Instrument Application

### Sizing Templates

Sizing templates facilitate the intraoperative selection of the appropriate implant.

Sizing templates for the 2.8 TriLock Olecranon Plates are available according to chapter "Implants, Instruments and Containers".

The sizing templates feature symbols that indicate the type of the screw hole and its position on the respective implant:



for a TriLock screw hole (locking) using a TriLock or a cortical screw



Sizing template with TriLock screw hole symbols

The article number of the sizing template (e.g. A-4856.11TP) corresponds to the article number of the sterile implant (e.g. A-4856.11S). The suffix TP stands for template.



A-4856.11TP  
Template for A-4856.11S

Use appropriate K-wires to temporarily fix the sizing template to the bone, if necessary.

#### Notice

Do not implant sizing templates.

Do not bend or cut sizing templates.

## Bending

If required, the plates can be bent with the plate bending pliers.

There are various options available for this.

### Warning

Wrong bending of the plate may lead to impaired functionality and postoperative construct failure.

The plate bending pliers have two different pins to protect the locking holes of flat and curved plates during the bending process.

Plate bending pliers with Vario pin (A-2040):

The curved radial head plates and the coronoid plate can be bent with the plate bending pliers with Vario pin (A-2040).

Plate bending pliers with pins (A-2047):

The flat olecranon plates and the lateral flap of the posterolateral distal humerus plates can only be bent with the plate bending pliers with pins (A-2047).

The plate bending pliers with pin are always used in pairs.

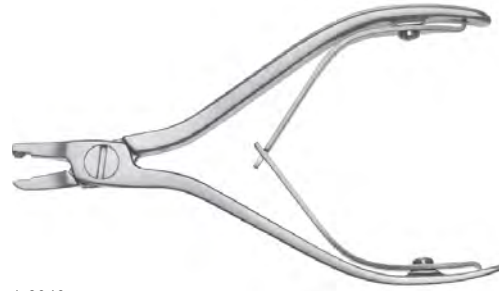

A-2040  
1.2-2.3 Plate Bending Pliers, with Vario Pin



A-2047  
2.0-2.8 Plate Bending Pliers, with Pins



The labeled side of the plate must always face upward («UP») when inserting the plate into the bending pliers.



When bending a flat plate (olecranon plate), the plate bending pliers with pins must be held so that the letters «F – FLAT PLATE THIS SIDE UP» are legible from above. This ensures that the plate holes are not damaged.

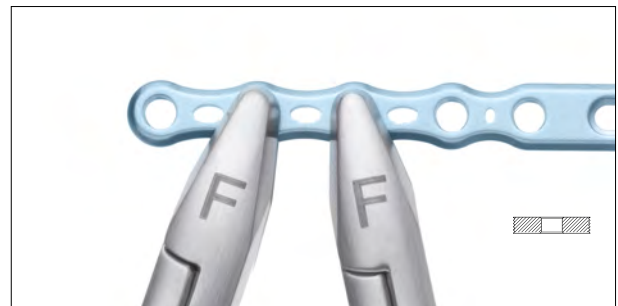

When bending the flap of the posterolateral plate, the plate bending pliers with pins must be held so that the letters «F – FLAT PLATE THIS SIDE UP» are legible from above. This ensures that the plate holes are not damaged.



While bending, the plate must always be held at two adjacent holes to prevent contour deformation of the intermediate plate hole.

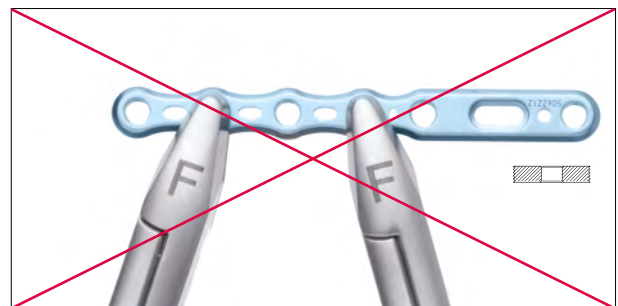

**Warning**

Do not bend the plate by more than 30°. Bending the plate further may deform the plate holes and may cause the plate to break postoperatively.

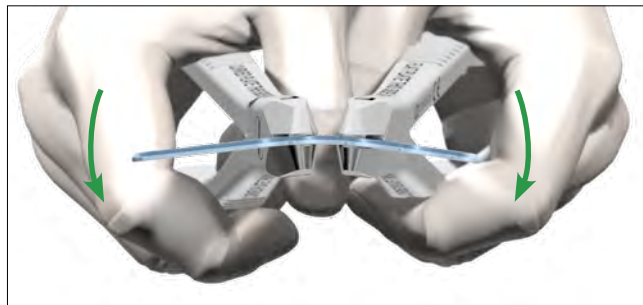

**Warning**

Repeatedly bending the plate in opposite directions may cause the plate to break postoperatively. Always use the provided plate bending pliers to avoid damaging the plate holes. Damaged plate holes prevent correct and secure seating of the screw in the plate and increase the risk of system failure.

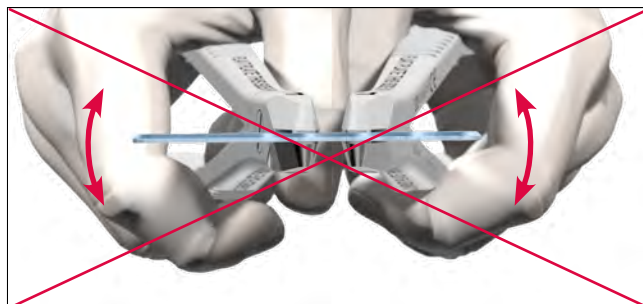

**Plate Bending Iron Elbow (A-2090)**

With the help of the plate bending irons (A-2090), the distal humerus plates can be twisted or bent out of the plate plane.



A-2090  
Plate Bending Iron Elbow

The medial and lateral distal humerus plates are to be bent in the open slits «med» and «lat», respectively, out of the plate plane and to be twisted in the closed slits «med» and «lat», respectively. The posterolateral distal humerus plates are both to be bent and twisted in the open slit «post-lat».

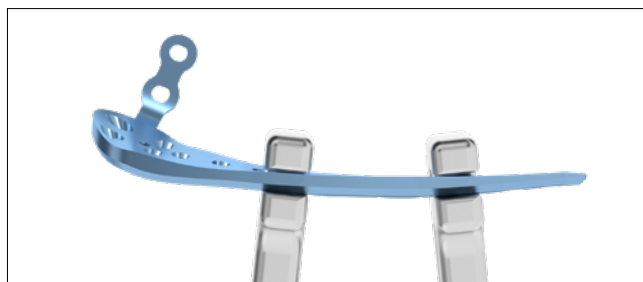
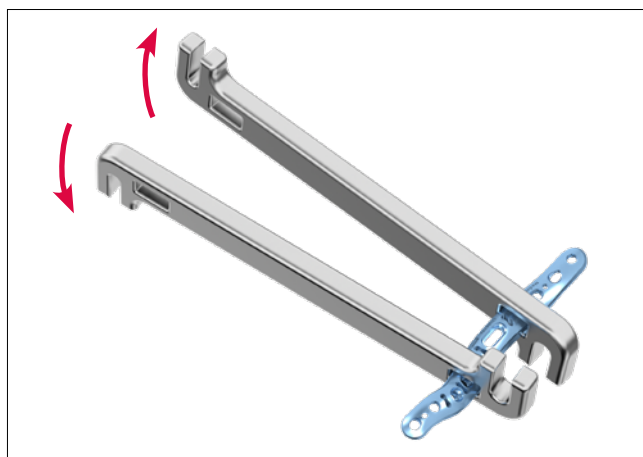

## Drilling

Color-coded twist drills are available for every APTUS system size. All twist drills are color coded with a ring system.

System size	Color Code
2.0	Blue
2.8	Orange



Core hole drills = one colored ring



Gliding hole drills = two colored rings

There are two different types of twist drills for every system size: the core hole drills are characterized by one colored ring, the gliding hole drills (for lag screw technique) are characterized by two colored rings.

### Warning

The drill must always be guided by the corresponding drill guide (A-2620 or A-2820). This prevents damage to the screw hole and protects the surrounding tissue from direct contact with the drill. The drill guide also serves to limit the pivoting angle.



The end with one colored bar of the double-ended drill guide (A-2820) can be used for all screw holes and for the insertion of independent screws (e.g. fragment fixation with screws alone).

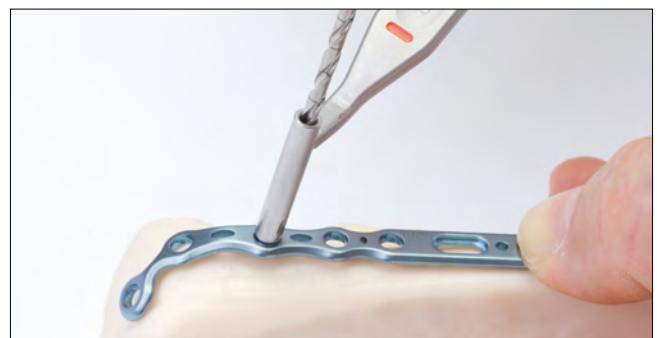

### Warning

For TriLock plates ensure that the screw holes are predrilled with a pivoting angle of no more than  $\pm 15^\circ$ . For this purpose, the drill guides feature a limit stop of  $\pm 15^\circ$ . A predrilled pivoting angle of  $>15^\circ$  no longer allows the TriLock screws to correctly lock in the plate.



## Assigning the Screw Length

The depth gauges (A-2032 for 2.0 screws and A-2836 for 2.8 screws) are used to assign the ideal screw length for use in monocortical or bicortical screw fixation of TriLock screws and cortical screws.



A-2032  
2.0/2.3 Depth Gauge



A-2836  
2.8 Depth Gauge

Retract the slider of the depth gauge.

The caliper of the depth gauge has a hooked tip that is either inserted to the bottom of the hole or is used to catch the far cortex of the bone. When using the depth gauge, the caliper stays static, only the slider is adjusted.



To assign the screw length, place the distal end of the slider onto the implant plate or directly onto the bone (e.g. for fracture fixation with lag screws).

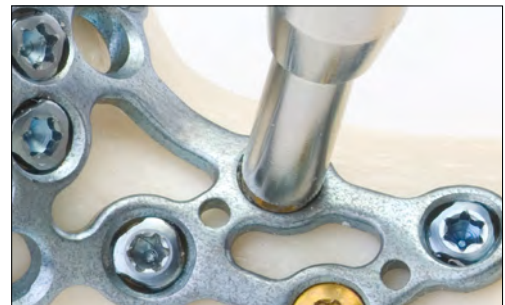

The ideal screw length for the assigned drill hole can be read on the scale of the depth gauge.

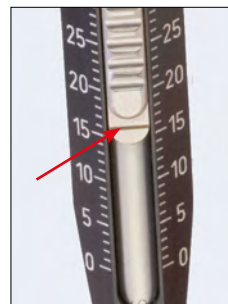

## Thread Preparation with the Tap

### Caution

All APTUS screws are self-tapping. In the case of very hard bone, especially in the shaft region of the distal humerus, it may be necessary to use the 2.8 tap (A-3839) to reduce the insertion torque of the 2.8 screws and to prevent fragment dislocation.

An unusually high resistance during the drilling of the core hole and/or an unusually high insertion torque of the screw can be signs of a particularly hard bone requiring prior tapping.

After drilling a core hole with a 2.8 core hole drill (A-3832 or A-3837, one orange ring), create a thread for the screw using the 2.8 tap (A-3839) together with the handle (A-2070 or A-2073).

Assign the screw length and insert the screw with the corresponding screwdriver (screwdriver blade A-2013 with handle A-2070 or A-2073).



A-3839  
2.8 Tap



A-2070  
Handle with Quick Connector, AO



A-2073  
Handle with Quick Connector, AO

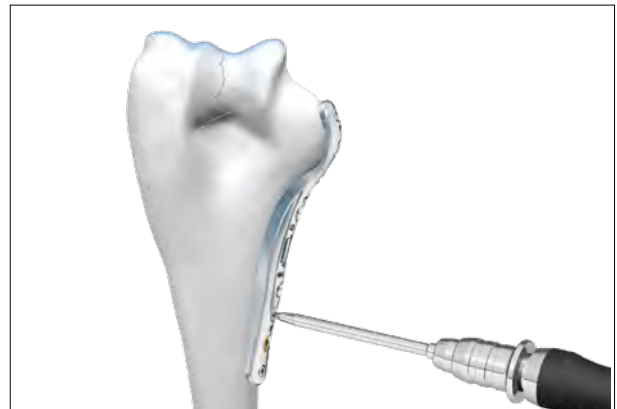

## Screw Pick-Up

The screwdrivers (A-2610, A-2070 and A-2073) and the screwdriver blade (A-2013) feature the patented HexaDrive self-holding system.

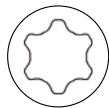

A-2610  
2.0/2.3 Screwdriver, HD6, Self-Holding



A-2070  
Handle with Quick Connector, AO



A-2073  
Handle with Quick Connector, AO



A-2013  
2.5/2.8 Screwdriver Blade, HD7, AO

To remove the screws from the implant container, insert the appropriately color-coded screwdriver perpendicularly into the screw head of the desired screw and pick up the screw with axial pressure.

### Notice

The screw will not hold without axial pressure.

### Caution

Vertically extract the screw from the compartment. Picking up the screw repeatedly may lead to permanent deformation of the self-retaining area of the HexaDrive inside the screw head. Therefore, the screw may no longer be able to be picked up correctly. In this case, a new screw has to be used.

### Notice

Check the screw length and diameter at the scale of the measuring module. The screw length is determined at the end of the screw head.

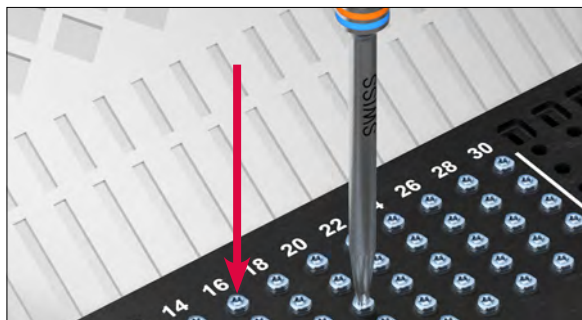

# Specific Instrument Application

## Aiming Device for Distal Humerus Plates

The aiming device facilitates the placement of long bicondylar screws in particular. With the device, the exit point of the drill can be determined before drilling.

It is used with the long drill bit (A-3837) which is stopped by the device when reaching the targeted exit point.

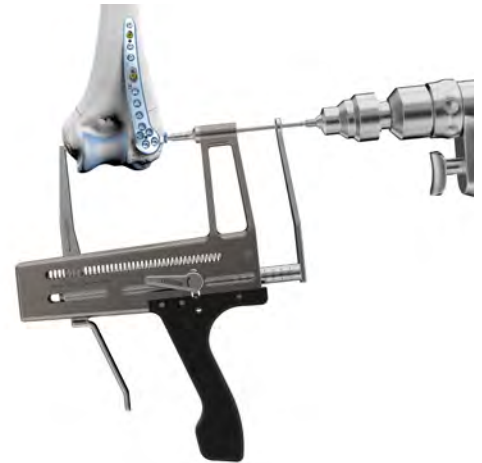

### Assembly of the aiming device

The aiming device consists of the components A-2095.1–4 which are stored individually in the container module.

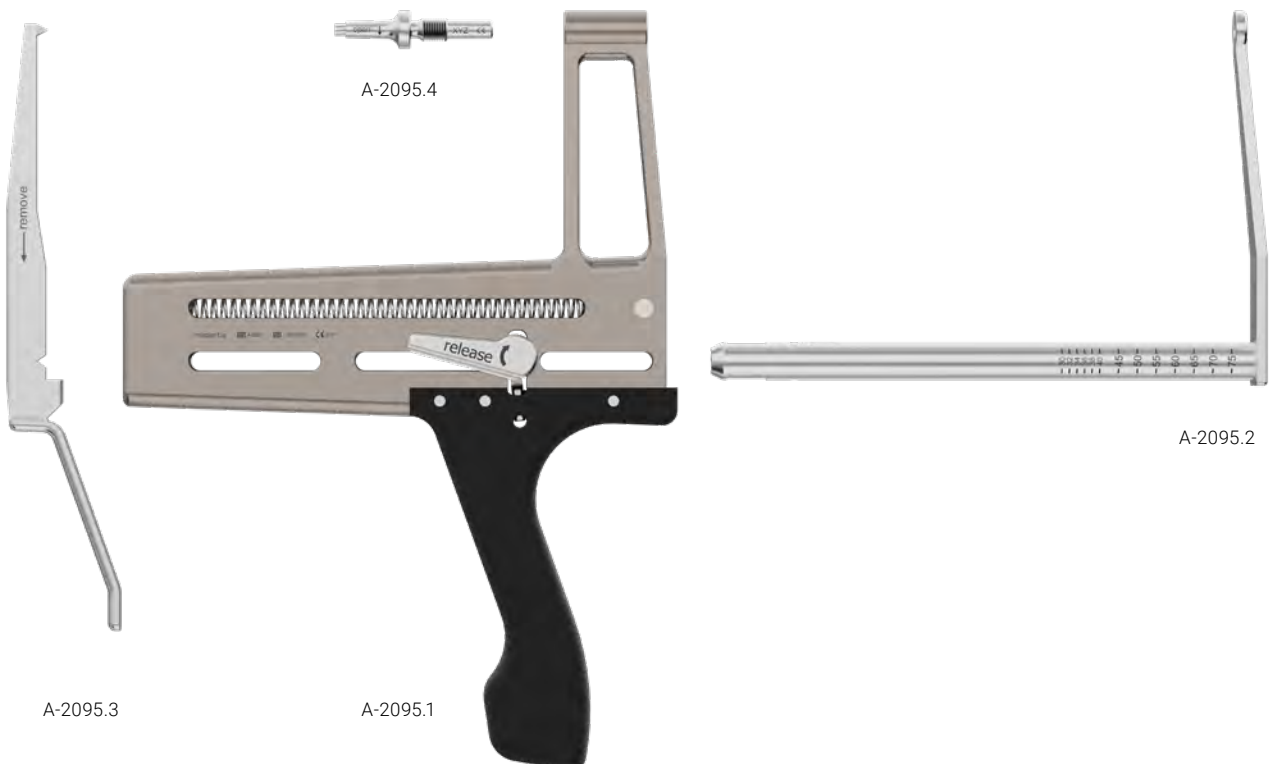

Article numbers of the components:

- A-2095.1 Frame with handle
- A-2095.2 Axle with drill stop
- A-2095.3 Trigger with target tip
- A-2095.4 Drill guide 2.8



Step 1

Insert the drill guide 2.8 (A-2095.4) into the frame with handle (A-2095.1).



Step 2

Slightly lift the handle «Release» to insert the axle with drill stop (A-2095.2).

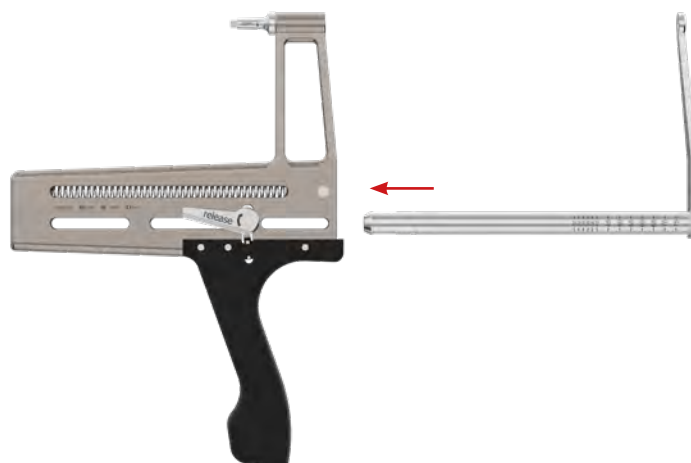

Step 3

Insert the trigger with target tip (A-2095.3).

The axle with drill stop must be completely inserted until it sits flush. A slight click should be heard at the end of the insertion.

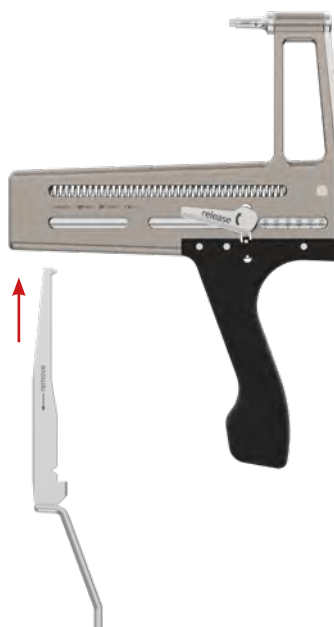

Also refer to "Assembly/Disassembly Instructions" at [www.medartis.com](http://www.medartis.com).



**Drilling through the aiming device**

Position the target tip of the aiming device at the place where the screw should exit. Now position the drill guide of the aiming device onto the screw hole in which the screw should be inserted by pulling the trigger handle. This reduces the distance between the target tip and the drill guide until both are in contact with the bone or the plate.



The device also exerts a slight compression on the fracture.

By pulling the trigger handle, the distance between the target tip and the drill guide is reduced.

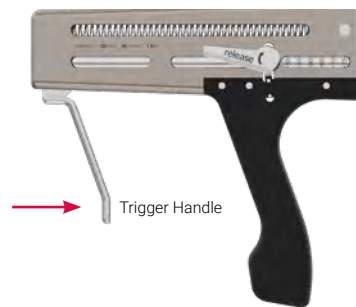

By pushing the «Release» handle, the distance is increased.

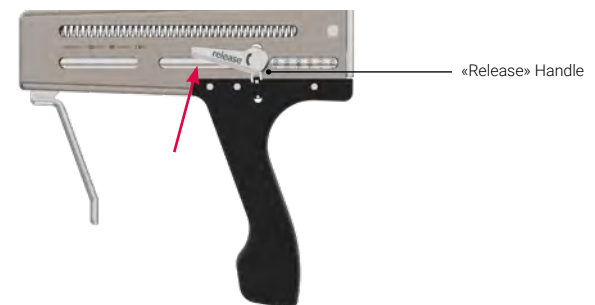

Insert the drill bit (A-3837) into the drill guide of the aiming device and drill the hole. The drill bit stops automatically just before it reaches the target tip.

When the device is in position on the bone and the plate, the screw length can be read on the scale on the axle.

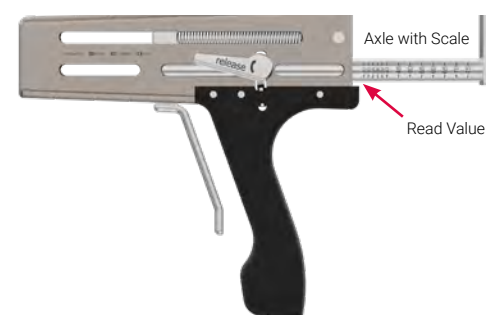

# Surgical Techniques

## General Surgical Techniques

### Lag Screw Techniques

Two lag screw techniques can be used, depending on the implant.

#### Warning

Incorrect application of the lag screw technique(s) may result in postoperative loss of reduction.

### Lag Screw Technique Using Cortical Screws

#### 1. Drilling the gliding hole

Drill the gliding hole using the twist drill marked with two rings (A-3431 Ø 2.1 mm or A-3834 Ø 2.9 mm) in combination with the end of the drill guide (A-2620 or A-2820) labeled with "LAG". Drill perpendicular to the fracture line.

Do not drill further than to the fracture line.

#### 2. Drilling the core hole

Insert the other end of the drill guide into the drilled gliding hole and use the twist drill for core holes with one ring (A-3434 Ø 1.6 mm, A-3832 Ø 2.35 mm, A-3837 Ø 2.35 mm) to drill the core hole.

#### 3. Compressing the fracture

Compress the fracture with the corresponding cortical screw.

#### 4. Optional steps before compression

If required, use the countersink (A-3835) to create a recess in the bone for the screw head.

#### Caution

Use the handle (A-2070 or A-2073) instead of a power tool to reduce the risk of countersinking too far through the near cortex.

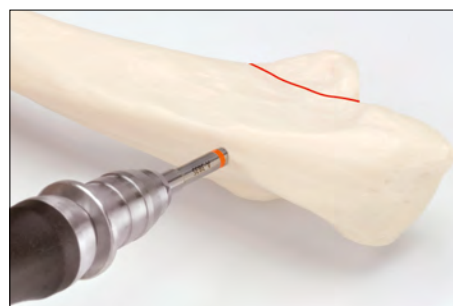
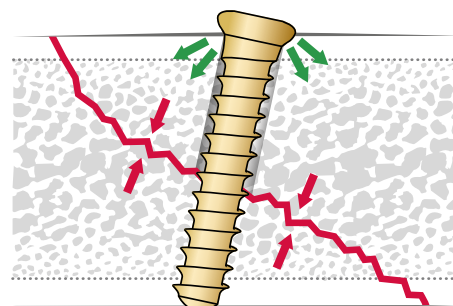
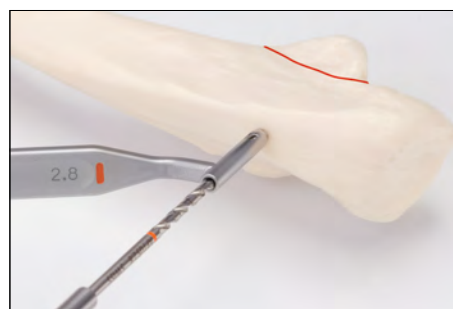

## Lag Screw Technique Using Lag Screws

For lag screws (A-5830.xx, Ø 2.8 mm) without thread in the shaft/neck, it is sufficient to drill a core hole using the drill guide and the core hole drill and to insert the screw.

### 1. Drilling the core hole

Drill the core hole using the twist drill for core holes with one ring (A- 3434 Ø 1.6 mm, A-3832 Ø 2.35 mm, A-3837 Ø 2.35 mm) in combination with the end of the drill guide (A-2820) marked with one colored bar. Drill perpendicular to the fracture line.



A-5861.xx/1  
2.8 Lag Screw, HexaDrive 7

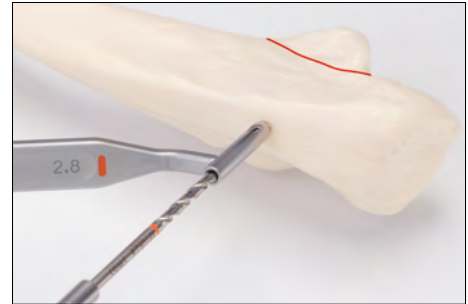

### 2. Compressing the fracture

Compress the fracture with the corresponding lag screw.

### 3. Optional steps before compression

If required, use the countersink (A-3835) to create a recess in the bone for the screw head.

#### Caution

Use the handle (A-2070 or A-2073) instead of a power tool to reduce the risk of countersinking too far through the near cortex.

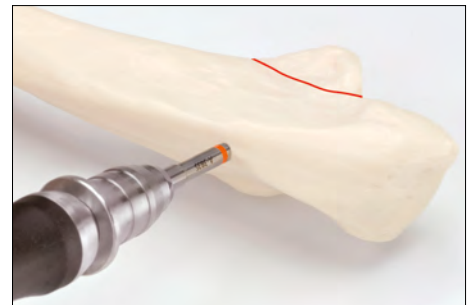

#### Warning

If the cortical bone is soft, a washer (A-4750.70) can be used for 2.8 cortical or lag screws in order to distribute the lag forces over a larger surface of the bone around the screw hole.

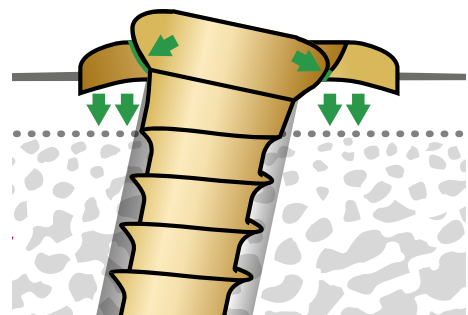

## Use of the compression hole

In every distal humerus plate (A-48456.29–54), the second most proximal screw hole can be used as a compression hole. It can be used if compression is to be exerted on the fracture. If compression is not required, the screw hole can be used as a regular screw hole with a cortical screw (A-5800-xx).

Before using the compression hole, make sure that the fragments distal to the fracture line are securely fixed to the plate.

Drill a core hole using the drill guide (A-2021) in the proximal part of the eccentric compression hole. Drill, assign the screw length and insert a cortical screw (A5800.xx) without tightening it.

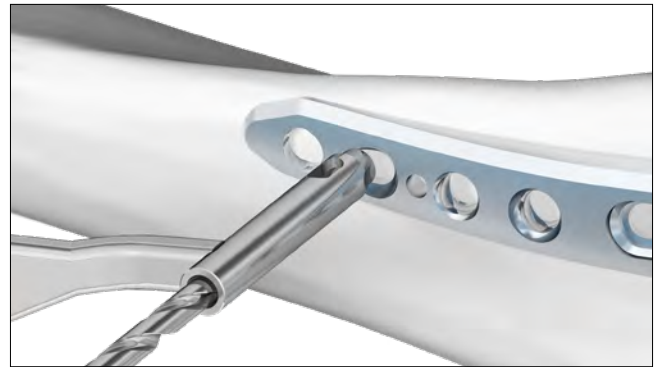

Untighten the screw in the oblong hole and remove all temporary K-wires and screws in the proximal part of the plate. Tighten the screw in the compression hole.

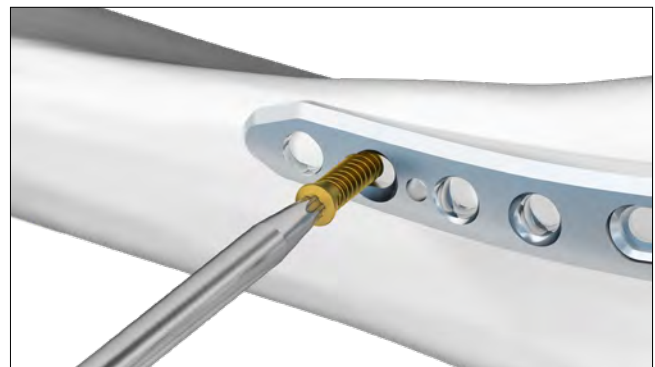

During the tightening of the screw in the compression hole, the screw head glides from the proximal part into the distal part of the eccentric hole, which moves the plate in proximal direction and exerts compression on the fracture.

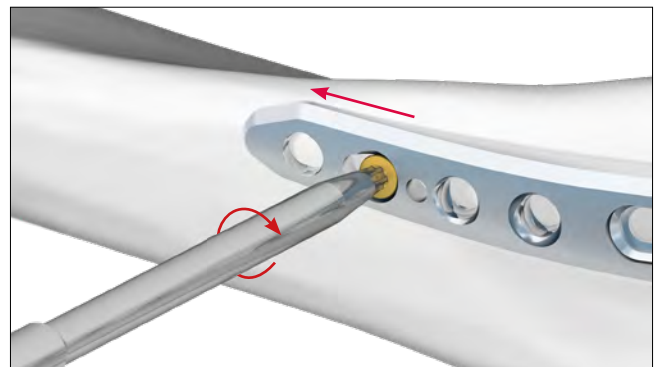

# Specific Surgical Techniques

## 2.0 Radial Head Plates

A-4656.68 and A-4656.69



A-4656.68  
Radial Head Rim plate



A-4656.69  
Radial Head Buttress Plate

### 1. Positioning the plate

After reduction of the fracture, select the appropriate radial head plate (A-4656.68 or A-4656.69) according to the fracture pattern.

If required, bend the plate with the plate bending pliers (A-2040) to achieve an adequate fit to the individual shape of the bone.



### Caution

The plates should be placed in the so-called safe zone whenever the fracture pattern allows it.

The safe zone is the part of the radial head that does not come into contact with the incisura radialis of the proximal ulna during forearm rotation. It measures about 110° of the radial head and has thinner, yellowish cartilage. With the forearm in the neutral position, the center of the safe zone is located 10° anteriorly to the lateral side of the radial head. \*

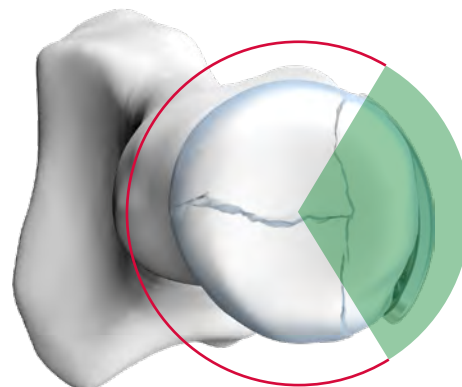

Safe Zone  
View on the articulation of the radial head from proximal.  
Right radius in neutral position.

For temporary plate fixation, 1.2 mm K-wires (A-5040.21) may be used.

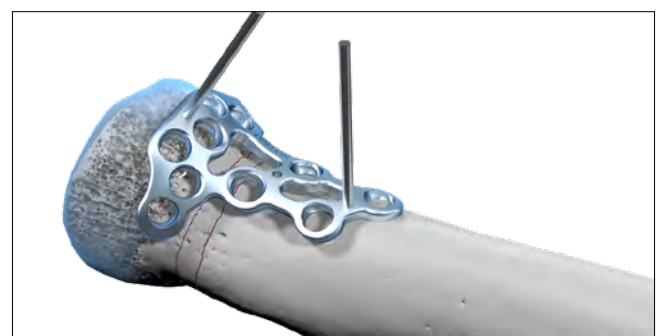

\* K. J. Burkhart, K. Wegmann, J. Dargel, C. Ries, L. P. Mueller, «Treatment of radial head and neck fractures: in favor of anatomical reconstruction», 2012, Eur J Trauma Emerg Surg, 38:593–603

## 2. Fixation of the plate

Start the fixation with a cortical screw (A-5400.xx) in the shaft region. Drill, assign the screw length and insert the screw.

This screw allows to pull the plate against the bone in order to establish a close contact.

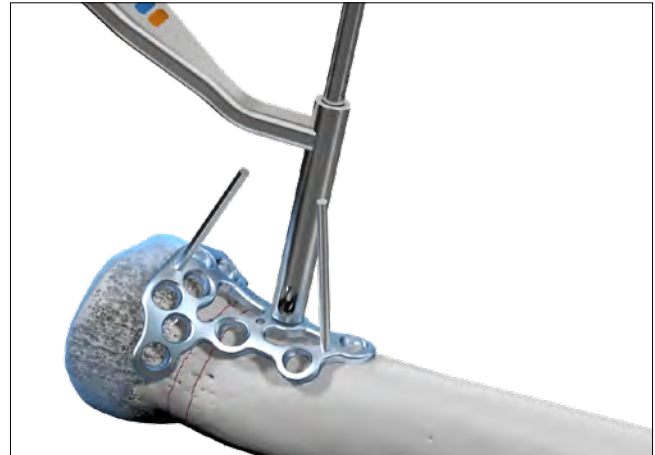

Repeat the steps above to fill the remaining screw holes with TriLock screws (A-5450.xx) or with cortical screws (A-5400.xx) wherever the fracture pattern requires it. Remove the K-wires.

Place at least three screws in the shaft and the proximal portion of the plate in order to achieve sufficient stability. A distribution of the screws into the head utilizing both proximal screw rows increases the stability of the fixation.

Angular stable screws generally provide a higher stability of the construct, especially in the case of a comminuted fracture or poor bone quality.

The multidirectionality of the locking ( $\pm 15^\circ$ ) and non-locking screws allows to individually address each fragment and avoid screw collisions.

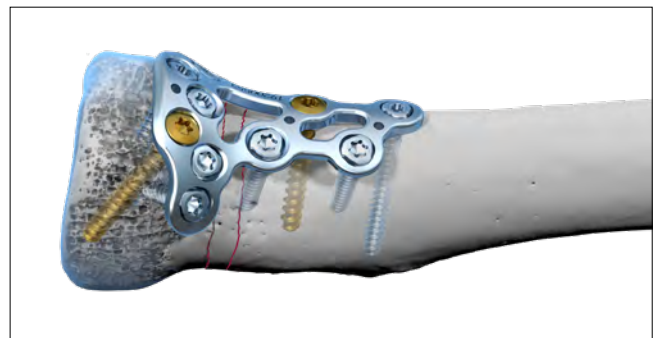

### Caution

Check the subchondral position of the screws clinically and radiographically, especially when using the radial head rim plate (A-4656.68).

## 2.0 Coronoid Plates

A-4656.80 and A-4656.81

### 1. Positioning the plate

If required, bend the plate with the plate bending pliers (A-2040) to achieve an adequate fit to the individual shape of the bone.



For temporary plate fixation, 1.2 mm K-wires (A-5040.21) may be used. Position the coronoid plate as proximal as possible. This allows for a subchondral fixation of the articular fragment by inserting screws in the proximal screw row.

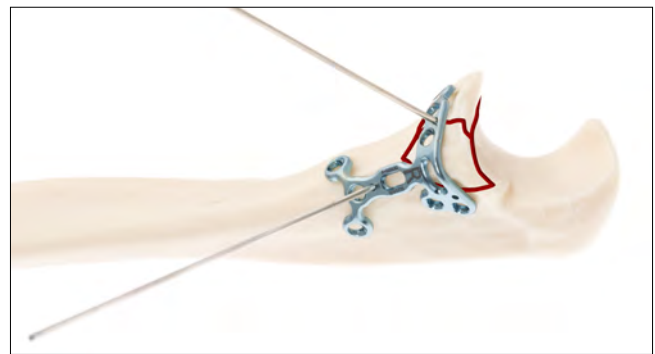

### 2. Fixation of the plate

Start the fixation with a cortical screw (A-5400.xx) in the center of the distal oblong hole. Drill, assign the screw length and insert the screw.

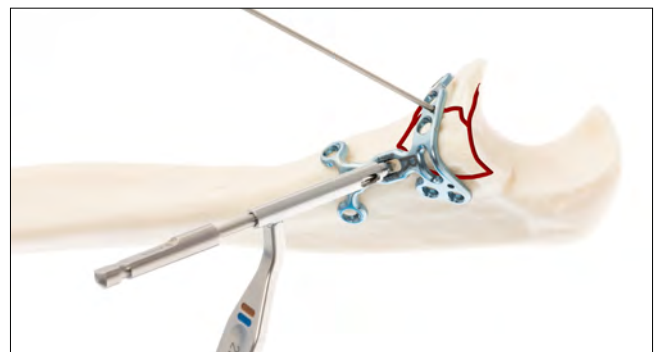

Do not completely tighten the screw. It is thus possible to slightly adjust the plate position for further distal or proximal final plate positioning. Remove all K-wires in the fragment to be adjusted in case the plate position needs to be changed.

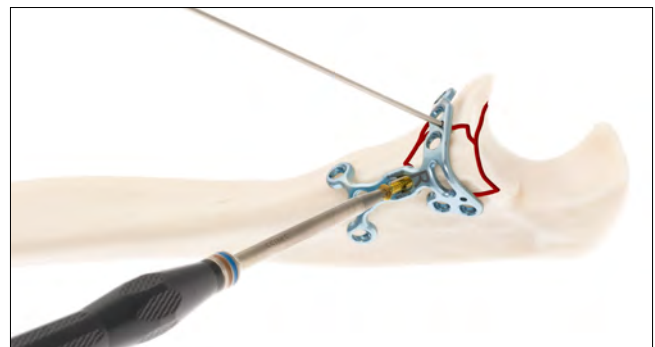



Correspondingly, fill the remaining screw holes with TriLock screws (A-5450.xx) or cortical screws (A-5400.xx) depending on the fracture pattern. Remove the K-Wires.

**Caution**

Use intraoperative X-ray control to verify the subchondral position of the screws.

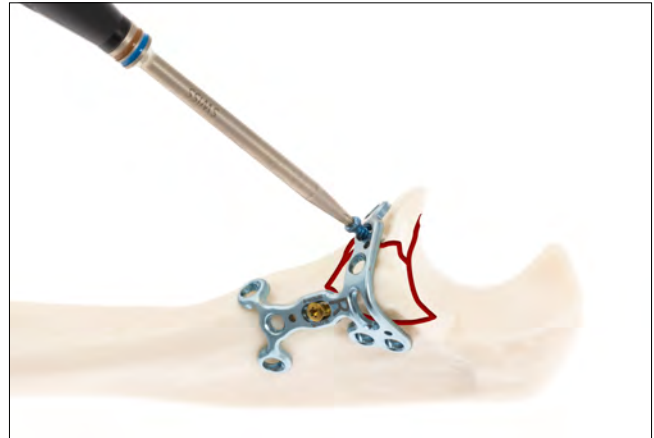

**Recommendation**

Depending on an anteromedial or medial Hotchkiss approach, either the anterior or the medial plate hole in the distal region can be used.

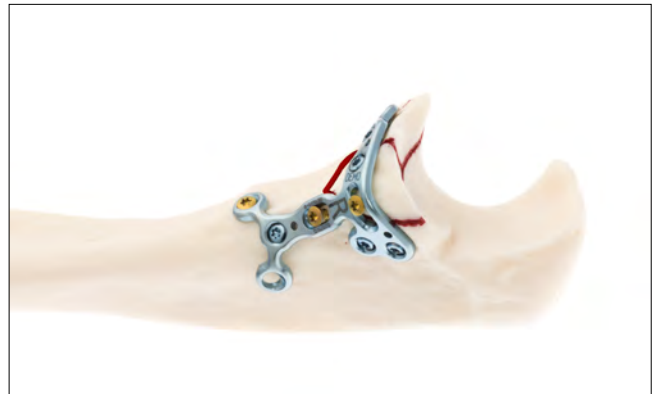

**Recommendation**

If insertion of a screw is not possible and the fracture allows for it, the proximal anterior arm can be used for buttressing of the fragment.

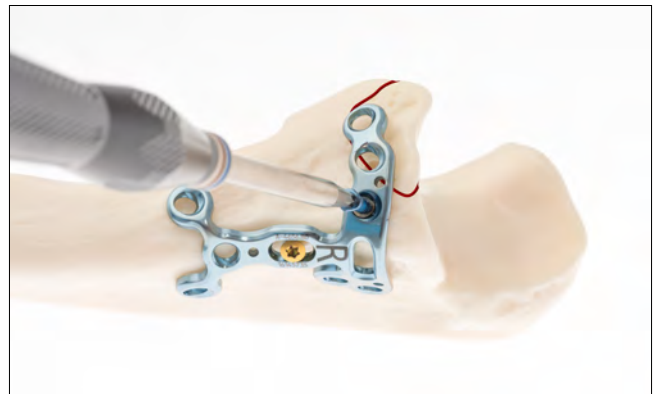



## 2.8 Olecranon Tension Plate

A-4856.01

### 1. Temporary fracture fixation

After reduction of the fracture, a K-wire (for example 1.6 mm, A-5040.51) is used for temporary fixation. The K-wire is positioned in the middle of the olecranon tip and aimed to the anterior cortex of the ulna. After insertion of the K-wire use reduction forceps to exert compression on the fracture and to make sure that the fracture is completely reduced. If necessary, drill a small hole in the distal cortex to securely anchor the distal tip of the reduction forceps away from the anticipated plate position.

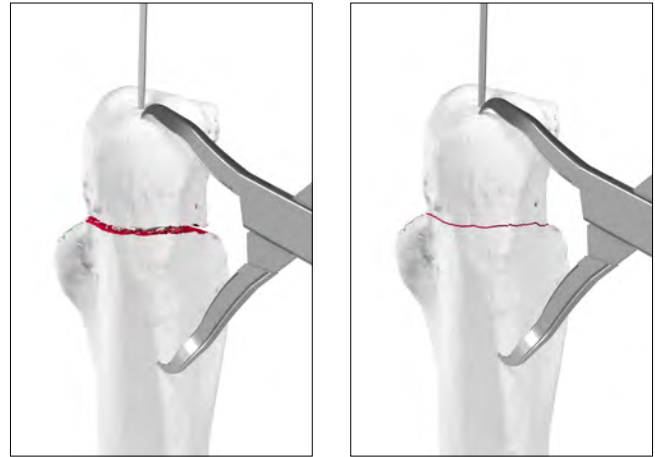

### 2. Precontouring the plate

Contour the plate by hand so that the two proximal holes fit around the tip of the olecranon. The distal holes come to lie on both sides laterally to the dorsal rim of the proximal ulna.

#### Warning

Repeatedly bending the plate in opposite directions may cause the plate to break

### 3. Positioning the plate

Make two small incisions into the triceps tendon on the olecranon and place the two proximal screw holes in direct contact with the bone of the proximal fragment. These incisions should be parallel to the muscle fibers.

#### Caution

Make sure that the plate lies tightly and symmetrically on the dorsal rim of the proximal ulna.

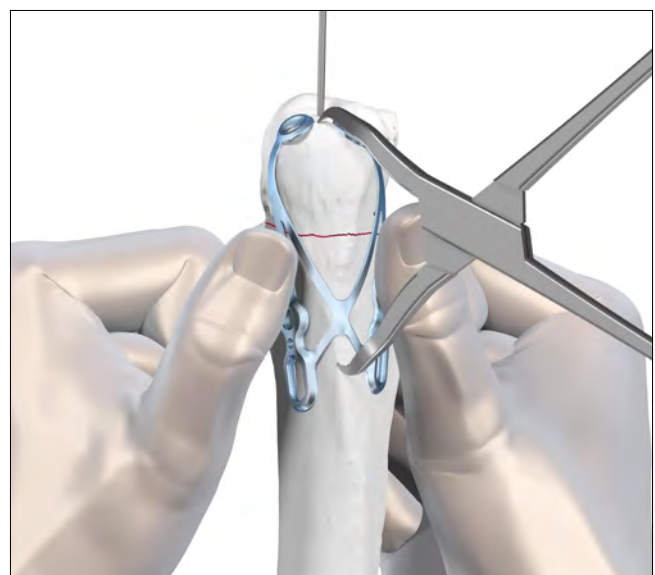

Temporarily fix the plate with two 1.6 mm K-wires (A-5040.41) through the K-wire holes. This ensures that the plate remains centered on the dorsal edge of the ulna while inserting the long lag screws in the next steps.

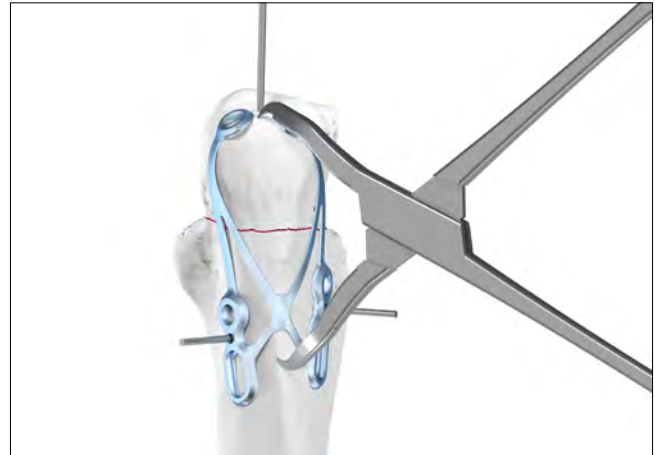

#### 4. Placing fracture-crossing screws

Two parallel, bicortical screws crossing the fracture are inserted in the proximal plate holes. The direction of these screws should be subchondral to the trochlear notch of the ulna, similar to the direction of the k-wires in classical tension band wiring.

Drill bicortically, assign the screw length and insert a lag screw (A-5830.xx) into the first proximal screw hole without fully tightening it yet.

Repeat the procedure with the second proximal plate hole.

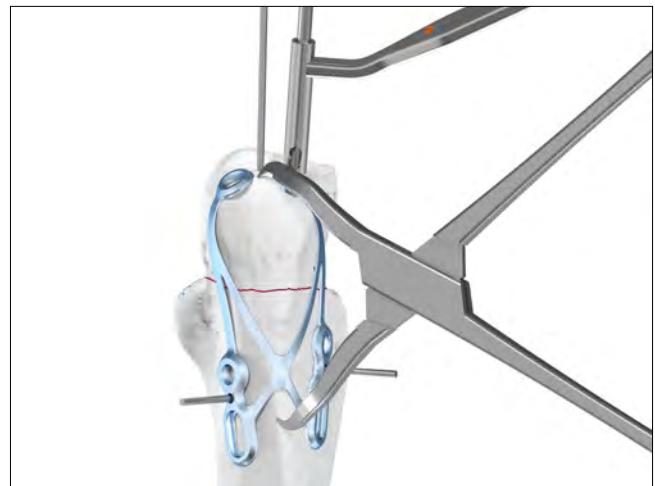

#### Caution

Use intraoperative X-ray control to verify the subchondral position of the screws.

Remove the two 1.6 mm K-wires.

#### 5. Closing of the fracture gap

Remove the central reduction K-wire.

Close the fracture gap by carefully tightening the two fracture-crossing lag screws and exert a slight compression on the fracture so as to complete the reduction.

Remove the reduction forceps

#### Warning

Only when the plate lies flat on the bone, the function of the tension relief is secured.

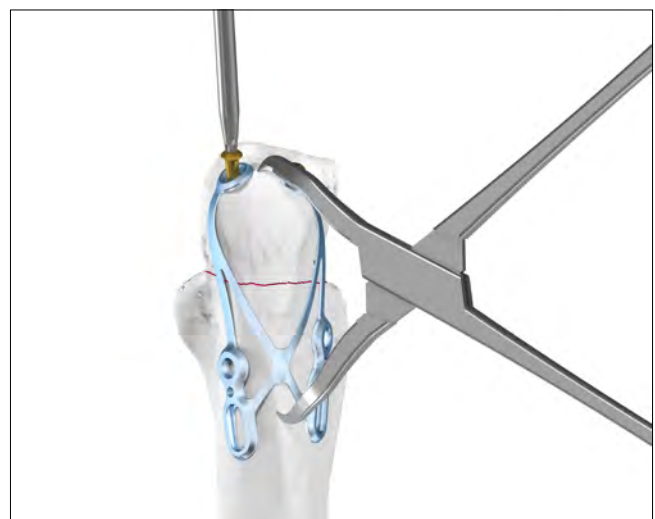

## 6. Insertion of distal screws

Drill a core hole through the center of one of the oblong holes, assign the screw length and insert a cortical screw (A-5800.xx). Do not tighten the screw yet.

### Caution

Make sure that the plate lies completely flat on the bone. If necessary, push the plate down with a finger to ensure an optimal fit

To put the plate under tension, hook the pointed reduction forceps (A-7003) in the distal part of the oblong hole and engage the forceps crosswise on the other side of the dorsal rim of the ulna. Tighten the reduction forceps until the longitudinal plate bar lies flat on the ulna.

Tighten the screw.

Drill another core hole through the neighboring plate hole, assign the screw length and insert a TriLock screw (A-5850.xx) or a cortical screw (A-5800.xx).

Angular stable screws generally provide a higher stability of the construct.

### Caution

When drilling the core hole from the medial side towards lateral, make sure the proximal radioulnar joint is not perforated. This can be checked clinically and radiographically.

Remove the pointed reduction forceps.

Repeat these steps on the other side of the plate, completing the fixation of the plate.

### Warning

The multidirectionality of the locking ( $\pm 15^\circ$ ) and non-locking screws allows to avoid screw collisions.

The small incisions in the triceps can be closed over the proximal screw holes.



## 2.8 Olecranon Double Plates

A-4856.10–A-4856.15

### 1. Plate selection

After reduction of the fracture, select the appropriate pair of olecranon double plates (A-4856.10–15). If necessary, bend the plates with the bending pliers (A-2047) in order to achieve an adequate fit to the individual shape of the bone.

#### Warning

The olecranon double plates must be used as a pair. Using only one plate will not provide sufficient stability.

The curved olecranon double plates (A-4856.10/13 and A-4856.11/14) are intended for proximal fractures that require fixation with at least two screws in the tip of the olecranon.

The straight olecranon double plates (A-4856.12/15) are intended for more distal fractures that do not require fracture fixation around the tip of the olecranon.

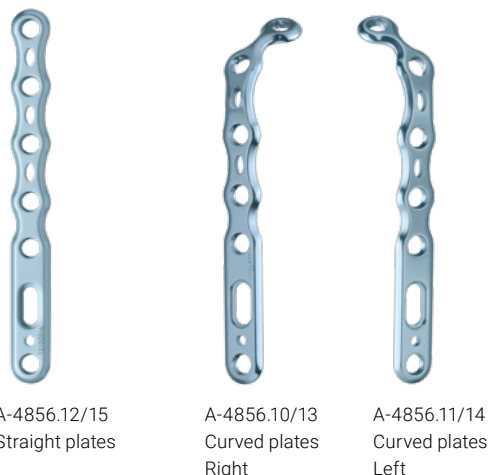

### 2. Positioning of the plate

If the curved double plates are used, two different plate placements are possible:

In most cases, the plates are placed with the proximal plate holes pointing away from each other. With this orientation, the plates fit most anatomies and only a small incision in the triceps tendon in the direction of its fibers is required.

Alternatively, the plates can be positioned with the proximal plate holes pointing towards each other. This enables the placement of long, fracture-crossing screws.

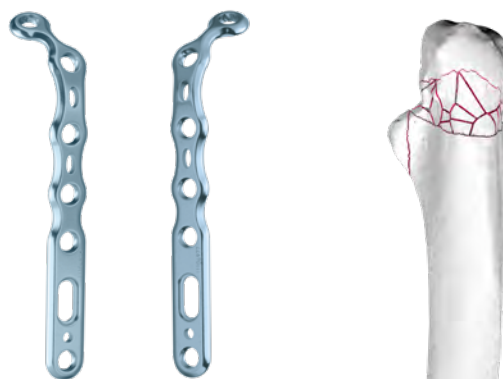

#### Caution

The plate orientation with the proximal holes pointing towards each other might not be possible with narrow olecrani as the plates could touch or overlap. This placement requires a larger cut into the triceps tendon across its fibers.

#### Caution

A dissection of the insertions of the M. anconeus and the M. flexor carpi ulnaris may be required to place the plates on the sides of the dorsal rim of the ulna. The soft tissue flaps can be used to cover the implants after fixation of the plates.

For temporary plate fixation, 1.6 mm K-wires (A-5040.41) or olive K-wires (A-5045.41/2S) may be used.



### 3. Fixation of the plate

Start the fixation of the first plate with a cortical screw (A-5800.xx) in the distal section of the oblong hole. Drill, assign the screw length and insert the screw.

#### Caution

In the case of very hard bone use the tap (A-3839) to reduce the insertion torque of the screw and to prevent fragment dislocation.

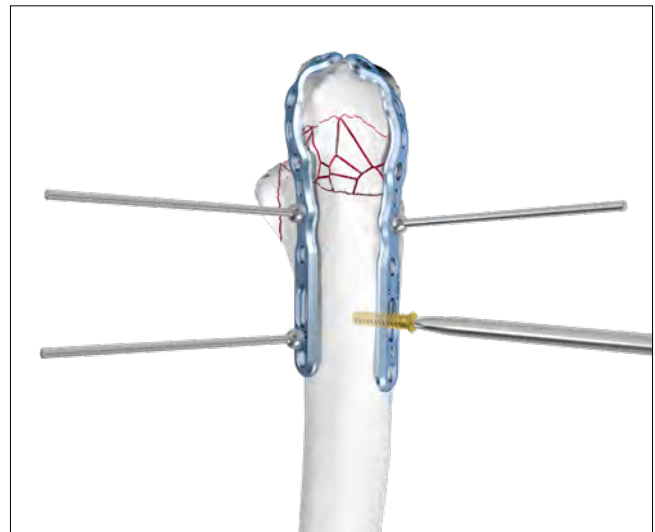

If long fracture-crossing screws are to be placed (proximal plate holes pointing towards each other) continue with a cortical screw or a TriLock screw (A-5850.xx) in the most proximal hole.

In case of a stable fracture with interfragmentary support, a fracture-crossing cortical screw allows to exert compression on the fracture and to pull the plate to the bone. When using a cortical screw, slightly loosen the screw in the oblong hole, remove any possible K-wires, tighten the proximal screw and then retighten the screw in the oblong hole.

In case of a comminuted unstable fracture, a TriLock screw should be used as compression on the fracture could narrow the joint.

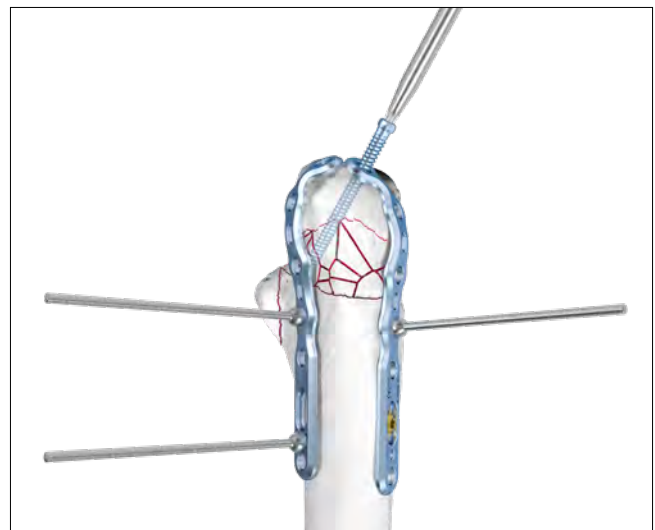

#### Caution

Use intraoperative X-ray control to verify the subchondral position of the proximal screws.

Repeat the steps above for the second plate.

Remove the K-wires.

Fill the remaining screw holes with TriLock screws (A-5850.xx) or cortical screws (A-5800.xx) wherever indicated by the fracture pattern.

For each plate, set at least two TriLock screws distally and proximally to the fracture to ensure sufficient stability.

**Warning**

The multidirectionality of the locking ( $\pm 15^\circ$ ) and non-locking screws allows to individually address each fragment and avoid screw collisions.



A fracture of the coronoid process that does not require fixation with a separate plate can be addressed with screws aiming towards the fragment.

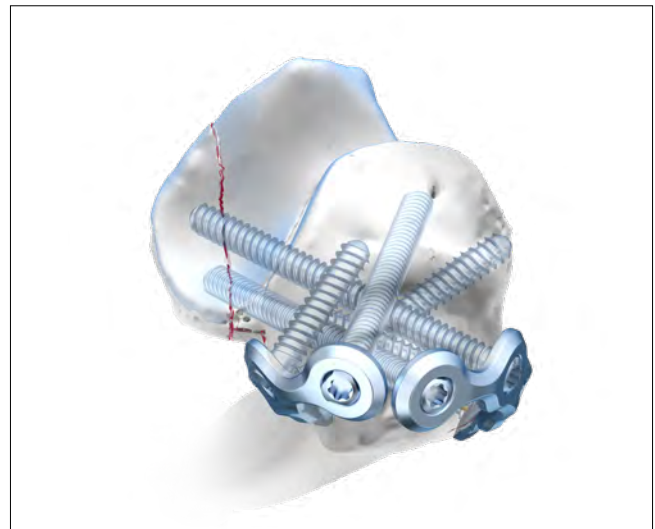

Close the incisions of the muscle insertions over the plates and cover the implants as much as possible.

## Distal Humerus Plates

A-4856.29–54

### 1. Plate selection

After reduction of the fracture, select the appropriate distal humerus plate or plate configuration (A-4856.29–54).

The plates can be used individually or as a pair in the case of complex fractures. The plate types available allow to choose between a 90° (perpendicular) or a 180° (parallel) configuration.

The 180° configuration may be preferred for very distal fractures requiring stabilization with transcondylar screws. The plates act as a template for the anatomic reduction of the fracture in the epicondylar area.

The 90° configuration may be advantageous in cases involving capitellar fractures, such as anterior shear fractures.

If necessary, bend the plates with the bending irons (A-2090) in order to achieve an adequate fit to the individual shape of the bone.

The flap on the posterolateral plates (A-4856.49–54) can be contoured with the plate bending pliers (A-2047). The flap can be removed fully (both screw holes) or partially (one screw hole) with suitable cutting pliers if not needed.



A-4856.29–34  
Medial plates  
left & right



A-4856.39–44  
Lateral plates  
left & right

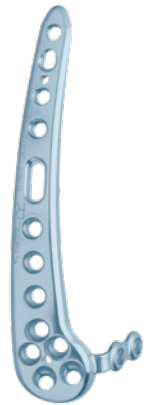

A-4856.49–54  
Posterolateral plates  
left & right



180° configuration:  
Combination of a medial  
(A-4856.29–34) and a  
lateral (A-4856.39–44)  
2.8 distal humerus plate

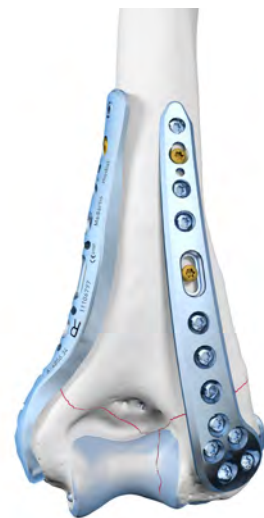

90° configuration:  
Combination of a medial  
(A-4856.29–34) and a  
posterolateral (A-4856.49–54)  
2.8 distal humerus plate



## 2. Positioning the plate

The medial plates (A-4856.29–34) are positioned on the medial ridge of the distal humerus.

The lateral plates (A-4856.39–44) are designed to fit the rim of the lateral epicondyle distally and twist to a posterior position on the shaft proximally.

The posterolateral plates (A-4856.49–55) are positioned far distally on the posterior side of the lateral column of the distal humerus. In addition, the two most distal screws are preangled distally to help reach very distal fragments of the capitellum.



Position of the medial plates (A-4856.29–34).



Position of the lateral pla



Position of the posterolateral plates (A-4856.49–54) showing the preangulation of the two most distal screw holes



## 2. Fixation of the plate

Prior to placement of the plate, lag screw fixation across the major fracture fragments may be performed (see chapter “Lag Screw Techniques”).

For temporary plate fixation, 1.6 mm K-wires (A-5040.41) or olive K-wires (A-5045.41/2S) may be used.

Start the fixation of the first plate with a cortical screw (A-5800.xx) in the oblong hole. Drill, assign the screw length and insert the screw.

### Caution

In the case of very hard bone use the tap (A-3839) to reduce the insertion torque of the screw and to prevent fragment dislocation.

If the plate position needs adjustment: remove all K-wires in the fragment to be adjusted, slightly loosen the cortical screw in the oblong hole, readjust the position of the plate and retighten the cortical screw.

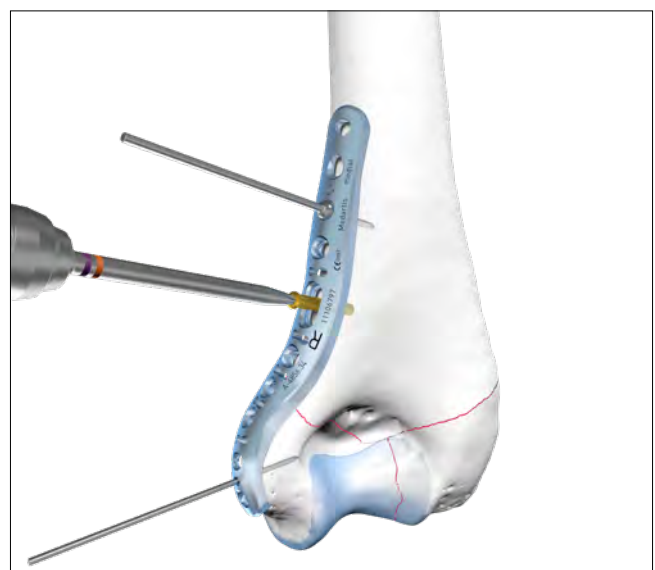

Fill the remaining screw holes with TriLock screws (A-5850.xx) or cortical screws (A-5800.xx) wherever indicated by the fracture pattern and remove all K-wires.

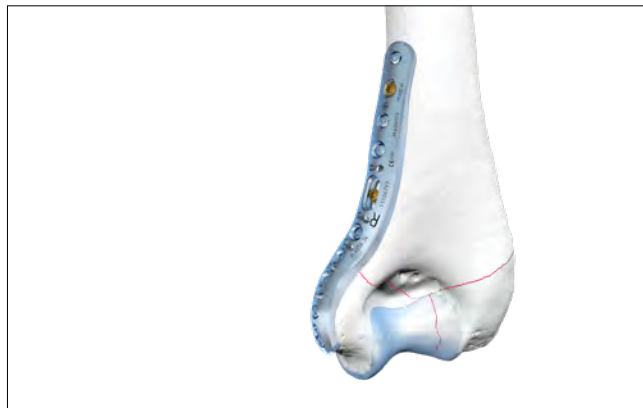

If a second plate is used, the implantation steps are identical to the ones of the first plate. After initial fixation of the plates with a cortical screw in the oblong hole, the sequence of the insertion of the rest of the screws can be varied between the plates according to the fracture pattern.

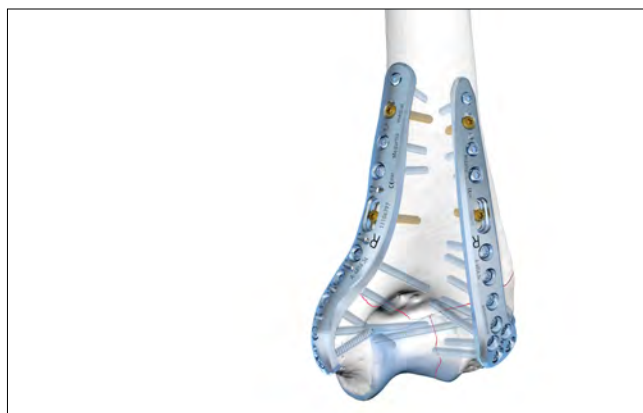

#### Warning

The plates are reduced in thickness towards their proximal end to reduce peak stresses in the humeral shaft. The stresses can be further reduced by making sure that the most proximal screws are positioned at different heights.

The second most proximal screw hole of every plate can be used as a compression hole if needed (see chapter "Use of the compression hole").

Cortical screws permit to pull a fragment to the plate. If a cortical screw is used to achieve appropriate plate and bone contact, it should be inserted before any locking screw is inserted into that fragment. Angular stable screws generally provide a higher stability of the construct, especially in case of a comminuted fracture or poor bone quality.

#### Warning

The multidirectionality of the locking ( $\pm 15^\circ$ ) and non-locking screws allows to individually address each fragment and avoid screw collisions.

In the case of articular fractures, it is generally advantageous to direct long subchondral screws from one epicondyle to the other. Use the aiming device to facilitate the placement of these long screws (see chapter "Aiming Device for Distal Humerus Plates").

#### Notice

Use intraoperative X-ray control to verify the subchondral position of the screws.

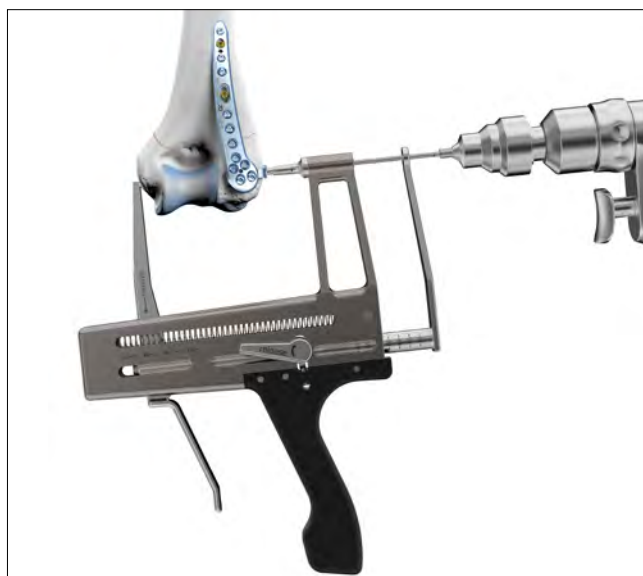

# Explantation

## Explantation of Elbow Plates

### 1. Removing the screws

Unlock all screws and remove them.

Generally, the order in which the screws are removed is not relevant. However, in case screws have been damaged upon implantation, the recommended sequence for the plate types below may help reduce the risk of screw breakage during explantation.

#### Olecranon:

For the explantation of curved double plates (A-4856.10/11/13/14) and the tension plate (A-4856.01), possible long fracture-crossing screws should be explanted last.

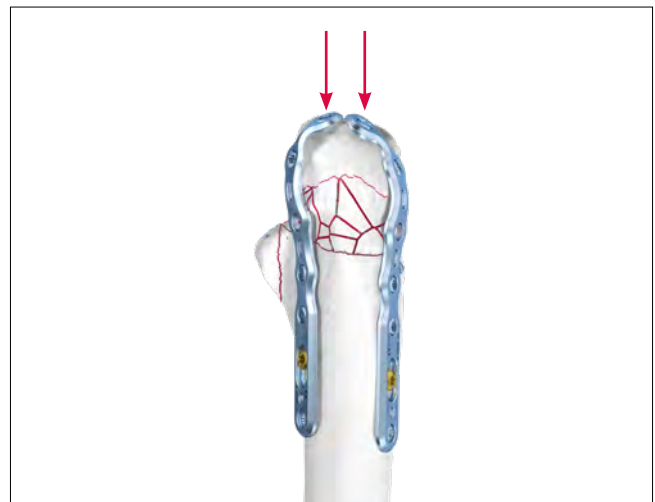

#### Distal Humerus (A-4856.29–54):

If the sequence of the original screw implantation is known, it should be reversed for the explantation.

Typically, long epicondylar screws are inserted at an early stage of implantation. Therefore, they should be explanted last and shorter screws should be removed first.

When explanting a posterolateral distal humerus plate (A-4856.49–54) with long transcondylar screws in the flap, remove these screws first.

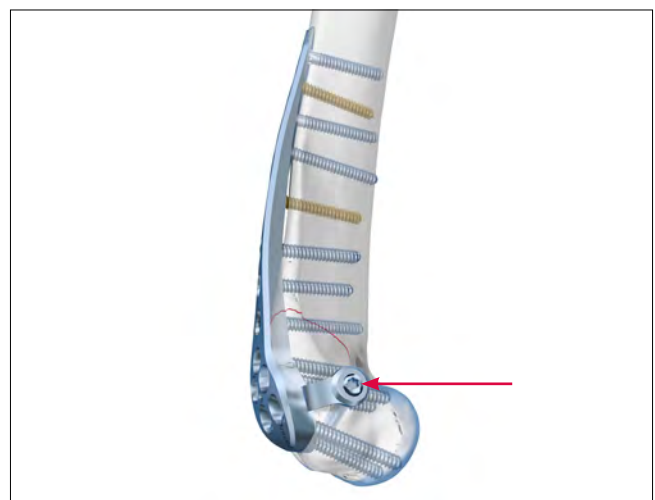

In case the plate sticks to the bone, use a periosteal elevator to carefully lift and detach it from the bone.

### Caution

When removing the screws, ensure that any bone ingrowth in the screw head has been removed, that the screwdriver/screw head connection is aligned in axial direction, and that a sufficient axial force is used between blade and screw.

# TriLock Locking Technology

## Correct Application of the TriLock Locking Technology

The screw is inserted through the plate hole into a predrilled canal in the bone. An increase of the tightening torque will be felt as soon as the screw head gets in contact with the plate surface.

This indicates the start of the «Insertion Phase» as the screw head starts entering the locking zone of the plate (section "A" in the diagram). Afterwards, a drop of the tightening torque

occurs (section "B" in the diagram). Finally the actual locking is initiated (section "C" in the diagram) as a friction connection is established between screw and plate when tightening firmly.

The torque applied during fastening of the screw is decisive for the quality of the locking as described in section "C" of the diagram.

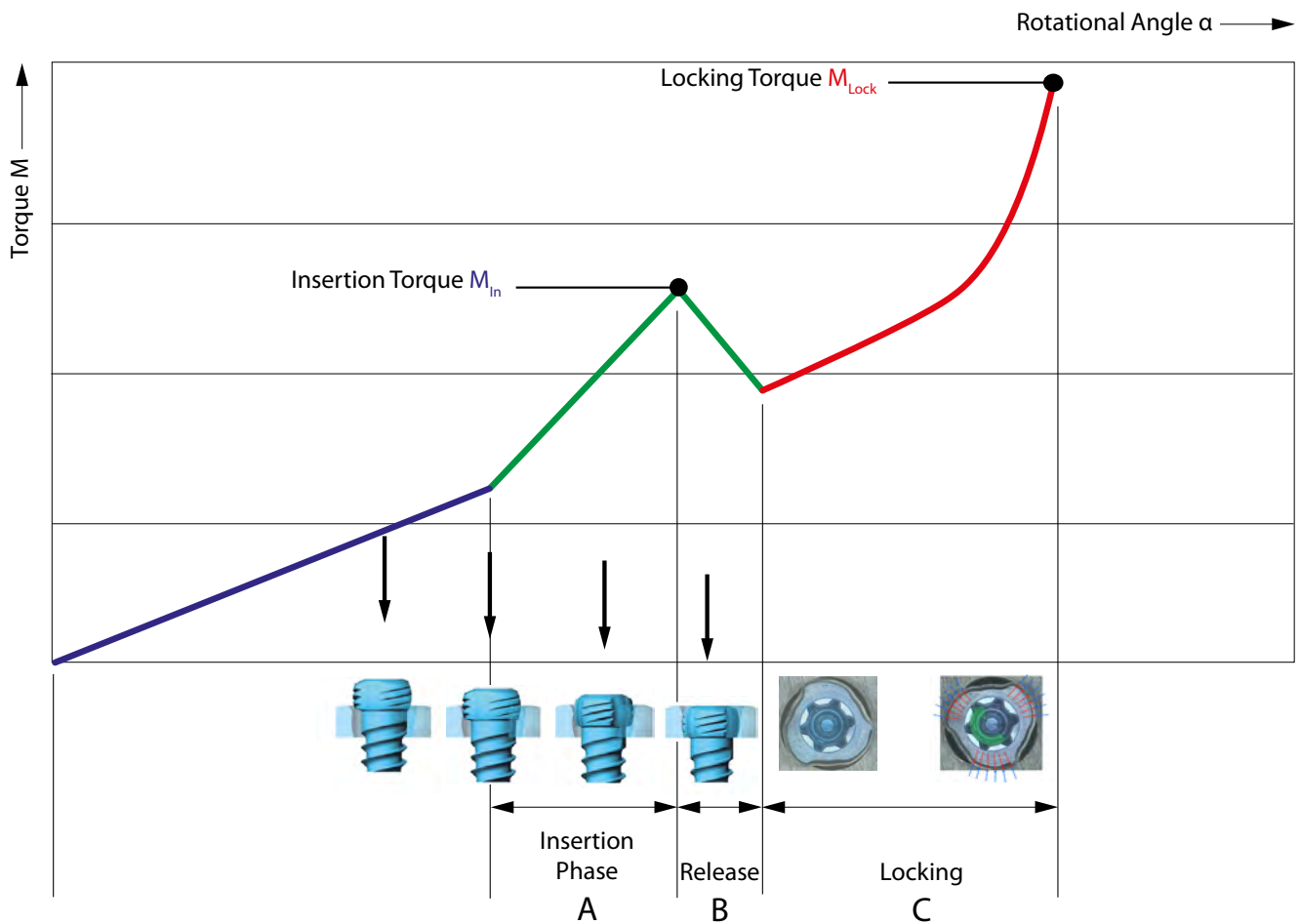

### Correct Locking ( $\pm 15^\circ$ ) of the TriLock Screws in the APTUS Elbow System 2.0, 2.3

The example below representatively depicts the correct locking position of a 2.5 screw in a straight 1.6 mm thick plate.

Correct locking occurs only when the screw head is locked flush with the locking contour (fig. 1 and 3).

However, if there is still a noticeable protrusion (fig. 2 and 4), the screw head has not completely reached the locking

position. In this case, the screw has to be retightened to obtain full penetration and proper locking. In case of poor bone quality a slight axial pressure might be necessary to achieve proper locking.

**After having reached the locking torque (MLock), do not further tighten the screw, otherwise the locking function cannot be guaranteed anymore.**

Correct: LOCKED



Figure 1

Incorrect: UNLOCKED

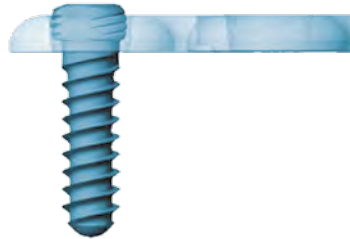

Figure 2

Correct: LOCKED

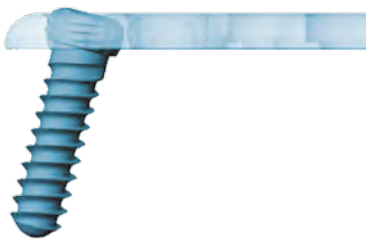

Figure 3

Incorrect: UNLOCKED

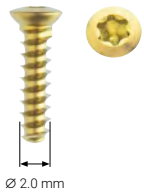

Figure 4

# Implants, Instruments and Containers

## 2.0 Cortical Screws, HexaDrive 6

Material: Titanium alloy (ASTM F136)



Length	Art. No.	STERILE	Pieces / Pkg	Art. No.	Pieces / Pkg
6 mm	A-5400.06/1	A-5400.06/1S	1	A-5400.06	5
8 mm	A-5400.08/1	A-5400.08/1S	1	A-5400.08	5
10 mm	A-5400.10/1	A-5400.10/1S	1	A-5400.10	5
12 mm	A-5400.12/1	A-5400.12/1S	1	A-5400.12	5
14 mm	A-5400.14/1	A-5400.14/1S	1	A-5400.14	5
16 mm	A-5400.16/1	A-5400.16/1S	1	A-5400.16	5
18 mm	A-5400.18/1	A-5400.18/1S	1	A-5400.18	5
20 mm	A-5400.20/1	A-5400.20/1S	1	A-5400.20	5
22 mm	A-5400.22/1	A-5400.22/1S	1	A-5400.22	5
24 mm	A-5400.24/1	A-5400.24/1S	1	A-5400.24	5
26 mm	A-5400.26/1	A-5400.26/1S	1	A-5400.26	5
28 mm	A-5400.28/1	A-5400.28/1S	1	A-5400.28	5
30 mm	A-5400.30/1	A-5400.30/1S	1	A-5400.30	5

## 2.0 TriLock Screws, HexaDrive 6

Material: Titanium alloy (ASTM F136)



Length	Art. No.	STERILE	Pieces / Pkg	Art. No.	Pieces / Pkg
6 mm	A-5450.06/1	A-5450.06/1S	1	A-5450.06	5
8 mm	A-5450.08/1	A-5450.08/1S	1	A-5450.08	5
10 mm	A-5450.10/1	A-5450.10/1S	1	A-5450.10	5
12 mm	A-5450.12/1	A-5450.12/1S	1	A-5450.12	5
14 mm	A-5450.14/1	A-5450.14/1S	1	A-5450.14	5
16 mm	A-5450.16/1	A-5450.16/1S	1	A-5450.16	5
18 mm	A-5450.18/1	A-5450.18/1S	1	A-5450.18	5
20 mm	A-5450.20/1	A-5450.20/1S	1	A-5450.20	5
22 mm	A-5450.22/1	A-5450.22/1S	1	A-5450.22	5
24 mm	A-5450.24/1	A-5450.24/1S	1	A-5450.24	5
26 mm	A-5450.26/1	A-5450.26/1S	1	A-5450.26	5
28 mm	A-5450.28/1	A-5450.28/1S	1	A-5450.28	5
30 mm	A-5450.30/1	A-5450.30/1S	1	A-5450.30	5

## 2.8 Cortical Screws, HexaDrive 7

Material: Titanium alloy (ASTM F136)



Length	Art. No.	STERILE	Pieces / Pkg	Art. No.	Pieces / Pkg
8 mm	A-5800.08/1	A-5800.08/1S	1	A-5800.08	5
10 mm	A-5800.10/1	A-5800.10/1S	1	A-5800.10	5
12 mm	A-5800.12/1	A-5800.12/1S	1	A-5800.12	5
14 mm	A-5800.14/1	A-5800.14/1S	1	A-5800.14	5
16 mm	A-5800.16/1	A-5800.16/1S	1	A-5800.16	5
18 mm	A-5800.18/1	A-5800.18/1S	1	A-5800.18	5
20 mm	A-5800.20/1	A-5800.20/1S	1	A-5800.20	5
22 mm	A-5800.22/1	A-5800.22/1S	1	A-5800.22	5
24 mm	A-5800.24/1	A-5800.24/1S	1	A-5800.24	5
26 mm	A-5800.26/1	A-5800.26/1S	1	A-5800.26	5
28 mm	A-5800.28/1	A-5800.28/1S	1	A-5800.28	5
30 mm	A-5800.30/1	A-5800.30/1S	1	A-5800.30	5
32 mm	A-5800.32/1	A-5800.32/1S	1	A-5800.32	5
34 mm	A-5800.34/1	A-5800.34/1S	1	A-5800.34	5
36 mm	A-5800.36/1	A-5800.36/1S	1	A-5800.36	5
38 mm	A-5800.38/1	A-5800.38/1S	1	A-5800.38	5
40 mm	A-5800.40/1	A-5800.40/1S	1	A-5800.40	5
45 mm	A-5800.45/1	A-5800.45/1S	1	A-5800.45	5
50 mm	A-5800.50/1	A-5800.50/1S	1	A-5800.50	5
55 mm	A-5800.55/1	A-5800.55/1S	1	A-5800.55	5
60 mm	A-5800.60/1	A-5800.60/1S	1	A-5800.60	5
65 mm	A-5800.65/1	A-5800.65/1S	1	A-5800.65	5
70 mm	A-5800.70/1	A-5800.70/1S	1	A-5800.70	5
75 mm	A-5800.75/1	A-5800.75/1S	1	A-5800.75	5

## 2.8 TriLock Screws, HexaDrive 7

Material: Titanium alloy (ASTM F136)

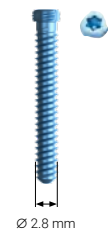

Length	Art. No.	STERILE	Pieces / Pkg	Art. No.	Pieces / Pkg
8 mm	A-5850.08/1	A-5850.08/1S	1	A-5850.08	5
10 mm	A-5850.10/1	A-5850.10/1S	1	A-5850.10	5
12 mm	A-5850.12/1	A-5850.12/1S	1	A-5850.12	5
14 mm	A-5850.14/1	A-5850.14/1S	1	A-5850.14	5
16 mm	A-5850.16/1	A-5850.16/1S	1	A-5850.16	5
18 mm	A-5850.18/1	A-5850.18/1S	1	A-5850.18	5
20 mm	A-5850.20/1	A-5850.20/1S	1	A-5850.20	5
22 mm	A-5850.22/1	A-5850.22/1S	1	A-5850.22	5
24 mm	A-5850.24/1	A-5850.24/1S	1	A-5850.24	5
26 mm	A-5850.26/1	A-5850.26/1S	1	A-5850.26	5
28 mm	A-5850.28/1	A-5850.28/1S	1	A-5850.28	5
30 mm	A-5850.30/1	A-5850.30/1S	1	A-5850.30	5
32 mm	A-5850.32/1	A-5850.32/1S	1	A-5850.32	5
34 mm	A-5850.34/1	A-5850.34/1S	1	A-5850.34	5
36 mm	A-5850.36/1	A-5850.36/1S	1	A-5850.36	5
38 mm	A-5850.38/1	A-5850.38/1S	1	A-5850.38	5
40 mm	A-5850.40/1	A-5850.40/1S	1	A-5850.40	5
45 mm	A-5850.45/1	A-5850.45/1S	1	A-5850.45	5
50 mm	A-5850.50/1	A-5850.50/1S	1	A-5850.50	5
55 mm	A-5850.55/1	A-5850.55/1S	1	A-5850.55	5
60 mm	A-5850.60/1	A-5850.60/1S	1	A-5850.60	5
65 mm	A-5850.65/1	A-5850.65/1S	1	A-5850.65	5
70 mm	A-5850.70/1	A-5850.70/1S	1	A-5850.70	5
75 mm	A-5850.75/1	A-5850.75/1S	1	A-5850.75	5

## 2.8 Lag Screws, HexaDrive 7

Material: Titanium alloy (ASTM F136)



Length	Art. No.	STERILE	Pieces / Pkg
40 mm	A-5830.40/1	A-5830.40/1S	1
45 mm	A-5830.45/1	A-5830.45/1S	1
50 mm	A-5830.50/1	A-5830.50/1S	1
55 mm	A-5830.55/1	A-5830.55/1S	1
60 mm	A-5830.60/1	A-5830.60/1S	1
65 mm	A-5830.65/1	A-5830.65/1S	1
70 mm	A-5830.70/1	A-5830.70/1S	1
75 mm	A-5830.75/1	A-5830.75/1S	1

## 2.5 / 2.8 Washer

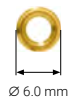

Description	Art. No.	STERILE	Pieces / Pkg	Art. No.	Pieces / Pkg	Material
concave	A-4700.70/1	A-4700.70/1S	1	A-4700.70	5	titanium alloy (ASTM F136)
biconcave	A-4750.70/1	A-4750.70/1S	1	A-4750.70	5	titanium (ASTM F67)



## 2.0 TriLock Radial Head Plates

Material: Titanium (ASTM F67)  
Plate thickness: 1.4 mm

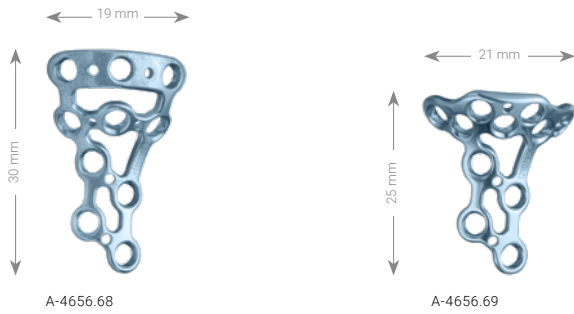

Art. No.	<b>STERILE</b>	Description	Holes	Pieces / Pkg
A-4656.68	A-4656.68S	rim plate	10	1
A-4656.69	A-4656.69S	buttress plate	11	1

## 2.0 TriLock Coronoid Plates

Material: Titanium (ASTM F67)  
Plate thickness: 1.6 mm

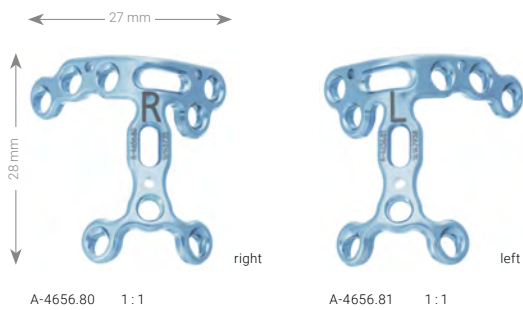

Art. No.	<b>STERILE</b>	Description	Holes	Pieces / Pkg
A-4656.80	A-4656.80S	right	10	1
A-4656.81	A-4656.81S	left	10	1

## 2.8 TriLock Olecranon Plates

Material : Titanium (ASTM F67)  
Plate thickness: 0.5 – 1.6 mm

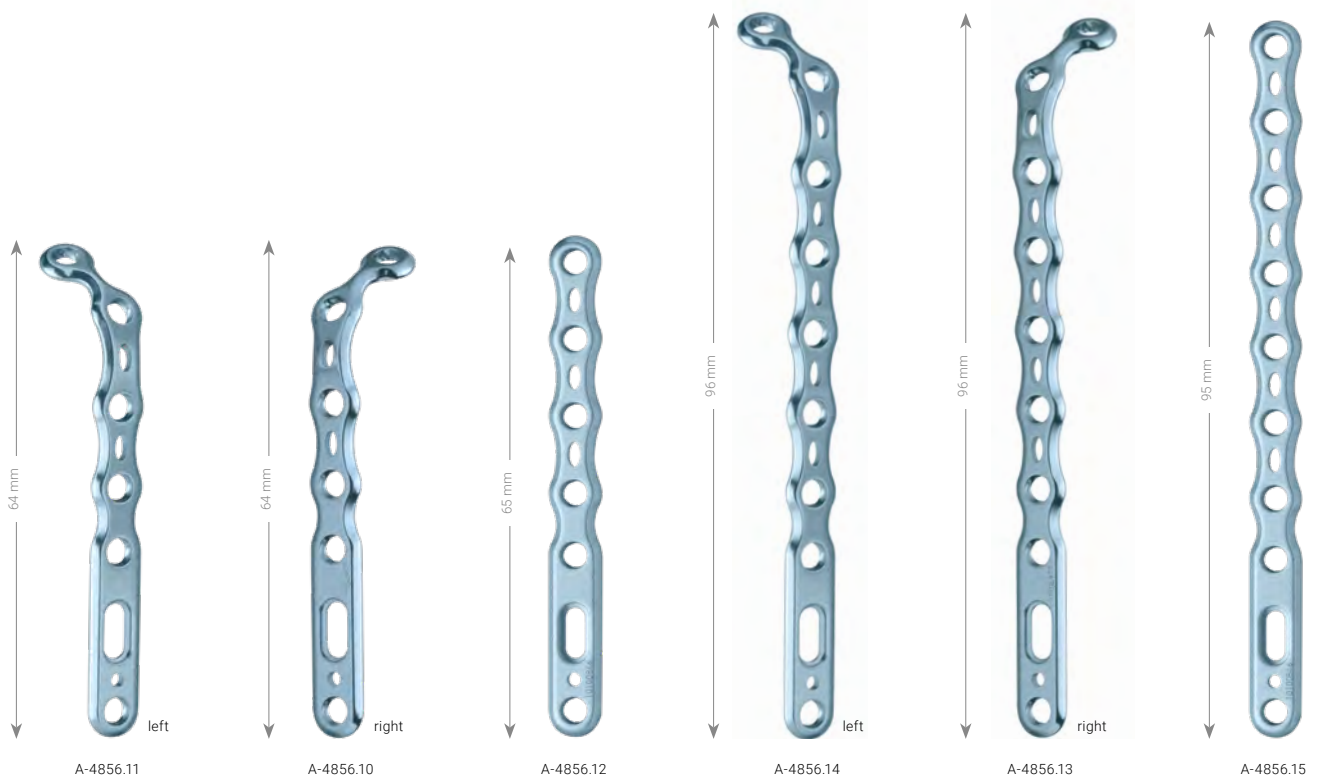
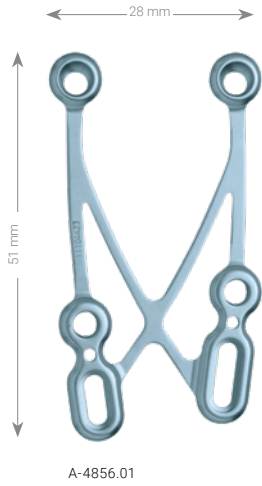

Art. No.	<b>STERILE</b>	Template	Description	Holes	Pieces / Pkg
A-4856.01	A-4856.01S		tension plate	6	1
A-4856.10	A-4856.10S	A-4856.10TP	right, short	7	1
A-4856.11	A-4856.11S	A-4856.11TP	left, short	7	1
A-4856.12	A-4856.12S	A-4856.12TP	straight, short	7	1
A-4856.13	A-4856.13S	A-4856.13TP	right, long	10	1
A-4856.14	A-4856.14S	A-4856.14TP	left, long	10	1
A-4856.15	A-4856.15S	A-4856.15TP	straight, long	10	1

## 2.8 TriLock Distal Humerus Plates, Medial

Material: Titanium (ASTM F67)  
 Plate thickness: 1.6 – 3.4 mm

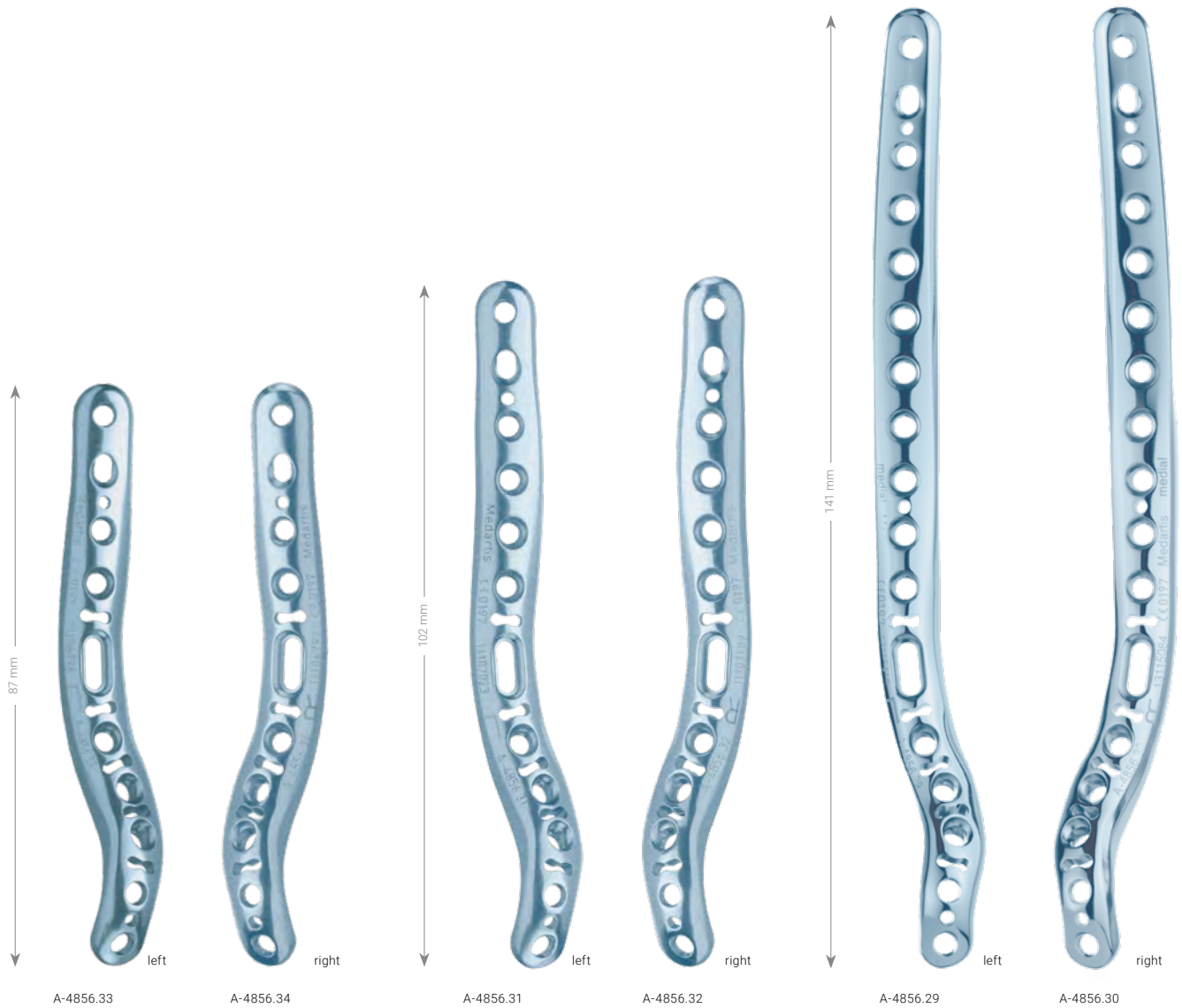

Art. No.	STERILE	Description	Holes	Pieces / Pkg
A-4856.29	A-4856.29S	left, long	17	1
A-4856.30	A-4856.30S	right, long	17	1
A-4856.31	A-4856.31S	left, medium	12	1
A-4856.32	A-4856.32S	right, medium	12	1
A-4856.33	A-4856.33S	left, short	10	1
A-4856.34	A-4856.34S	right, short	10	1

## 2.8 TriLock Distal Humerus Plates, Lateral

Material: Titanium (ASTM F67)  
Plate thickness: 1.6 – 3.4 mm

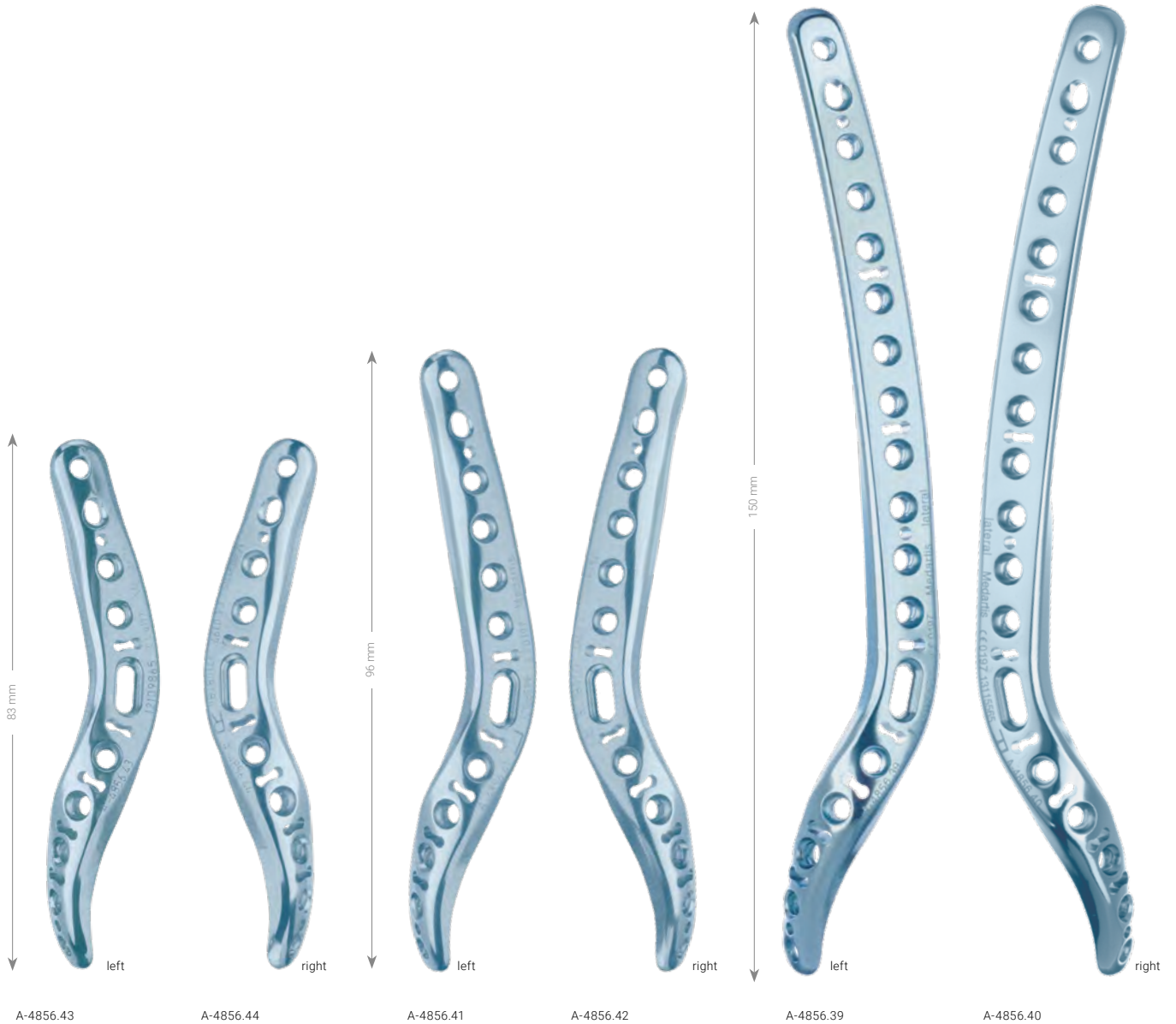

Art. No.	STERILE	Description	Holes	Pieces / Pkg
A-4856.39	A-4856.39S	left, long	18	1
A-4856.40	A-4856.40S	right, long	18	1
A-4856.41	A-4856.41S	left, medium	12	1
A-4856.42	A-4856.42S	right, medium	12	1
A-4856.43	A-4856.43S	left, short	10	1
A-4856.44	A-4856.44S	right, short	10	1

## 2.8 TriLock Distal Humerus Plates, Posterolateral

Material: Titanium (ASTM F67)  
Plate thickness: 1.6 – 3.4 mm

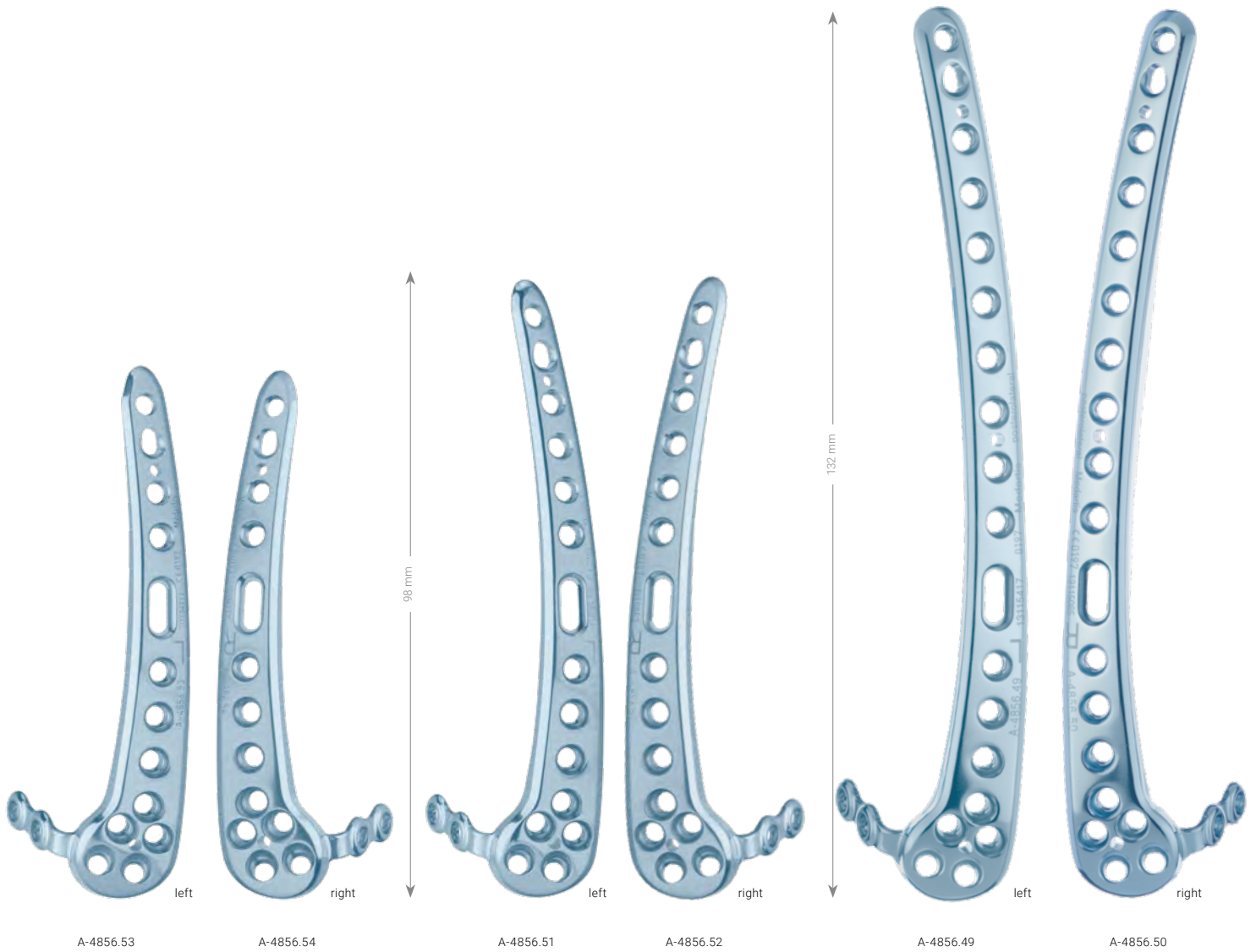

Art. No.	<b>STERILE</b>	Description	Holes	Pieces / Pkg
A-4856.49	A-4856.49S	left, long	21	1
A-4856.50	A-4856.50S	right, long	21	1
A-4856.51	A-4856.51S	left, medium	17	1
A-4856.52	A-4856.52S	right, medium	17	1
A-4856.53	A-4856.53S	left, short	15	1
A-4856.54	A-4856.54S	right, short	15	1

## 2.8 Aiming Device (Individual Parts)

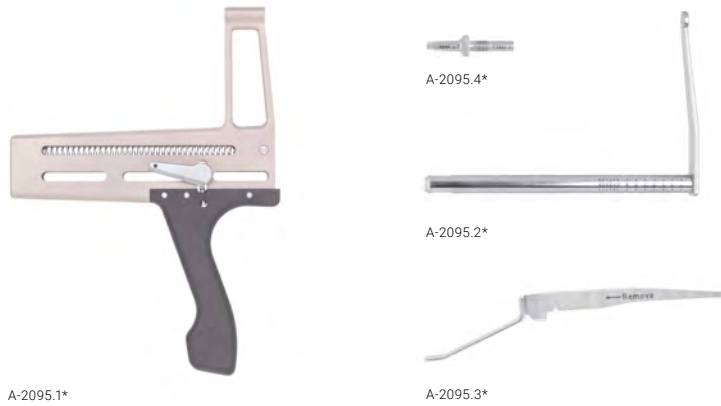

Art. No.	System Size	Description	Pieces / Pkg
A-2095.1*	2.8	aiming device, frame with handle	1
A-2095.2*	2.8	aiming device, drill stop	1
A-2095.3*	2.8	aiming device, trigger with target tip	1
A-2095.4*	2.8	aiming device, drill guide 2.8	1

## Twist Drills



A-3434



A-3431



A-3832



A-3837



A-3834

Art. No.	STERILE	System Size	Ø	Stop	Length	Shaft End	Pieces / Pkg
A-3431	A-3431S	2.0	2.1 mm (for gliding hole)	10 mm	66 mm	AO Quick Coupling	1
A-3434	A-3434S	2.0	1.6 mm	30 mm	86 mm	AO Quick Coupling	1
A-3832	A-3832S	2.8	2.35 mm	50 mm	101 mm	AO Quick Coupling	1
A-3834	A-3834S	2.8	2.9 mm (for gliding hole)	10 mm	61 mm	AO Quick Coupling	1
A-3837	A-3837S	2.8	2.35 mm	38 mm	151 mm	AO Quick Coupling	1

## Countersink for Cortical Screws



Art. No.	STERILE	System Size	∅	Length	Shaft End	Pieces / Pkg
A-3835	A-3835S	2.8	3.7 mm	45 mm	AO Quick Coupling	1

## 2.8 Tap



Art. No.	System Size	Thread Length	Shaft End	Pieces / Pkg
A-3839	2.8	75 mm	AO Quick Coupling	1

## K-Wires, Stainless Steel



Art. No.	STERILE	∅	Description	Length	Pieces / Pkg
A-5040.21		1.2 mm	trocar	150 mm	10
	A-5040.21/2S	1.2 mm	trocar	150 mm	2
A-5040.41		1.6 mm	trocar	150 mm	10
	A-5040.41/2S	1.6 mm	trocar	150 mm	2
A-5040.51		1.8 mm	trocar	150 mm	10
	A-5040.51/2S	1.8 mm	trocar	150 mm	2
A-5042.21		1.2 mm	lancet	150 mm	10
	A-5042.21/2S	1.2 mm	lancet	150 mm	2
A-5042.41		1.6 mm	lancet	150 mm	10
	A-5042.41/2S	1.6 mm	lancet	150 mm	2
A-5042.51		1.8 mm	lancet	150 mm	10
	A-5042.51/2S	1.8 mm	lancet	150 mm	2

## Drill Guides



A-2620



A-2820

Scale 1 : 2

Art. No.	System Size	Description	Length	Pieces / Pkg
A-2620	2.0 / 2.3	for core and gliding hole	150 mm	1
A-2820	2.8	for core and gliding hole	146 mm	1

### Depth Gauges



A-2032



A-2836

Art. No.	System Size	Length	Pieces / Pkg
A-2032	2.0 / 2.3	151 mm	1
A-2836	2.8	220 mm	1

### Screwdriver, Self-Holding



HD6

Art. No.	System Size	Interface	Length	Pieces / Pkg
A-2610	2.0 / 2.3	HD6	153 mm	1

### Handles with Quick Connector



A-2070



A-2073

Art. No.	Description	Length	for Shaft End	Pieces / Pkg
A-2070		119 mm	AO Quick Coupling	1
A-2073	with twist cap	124 mm	AO Quick Coupling	1

### Screwdriver Blade, Self-Holding, HexaDrive 7



HD7

Art. No.	System Size	Interface	Length	Shaft End	Pieces / Pkg
A-2013	2.5 / 2.8	HD7	75 mm	AO Quick Coupling	1



### Plate Bending Pliers



Scale 1 : 3

Art. No.	System Size	Description	Length	Pieces / Pkg
A-2040	1.2 – 2.3	plate bending pliers with Vario pin	119 mm	1
A-2047	2.0 – 2.8	plate bending pliers with pins	158 mm	1

### Plate Bending Iron



Art. No.	System Size	Length	Pieces / Pkg
A-2090	2.8	160 mm	1

### Forceps



Scale 1 : 3  
\*Scale 1 : 4

Art. No.	Description	Length	Pieces / Pkg
A-7003	reduction forceps	130 mm	1
A-7014 *	reduction forceps	205 mm	1
A-7012	bone holding forceps	140 mm	1
A-7015	bone holding forceps	180 mm	1

### Periosteal Elevator



Art. No.	Description	Width	Length	Pieces / Pkg
A-7016	round edges	6 mm	190 mm	1

### Wound Retractor Langenbeck



Art. No.	Description	Length	Pieces / Pkg
A-7018	44 x 10 mm	210 mm	1

### Bone Elevator Hohmann



Art. No.	Description	Length	Pieces / Pkg
A-7017	8 mm	220 mm	1

## Cases, Trays

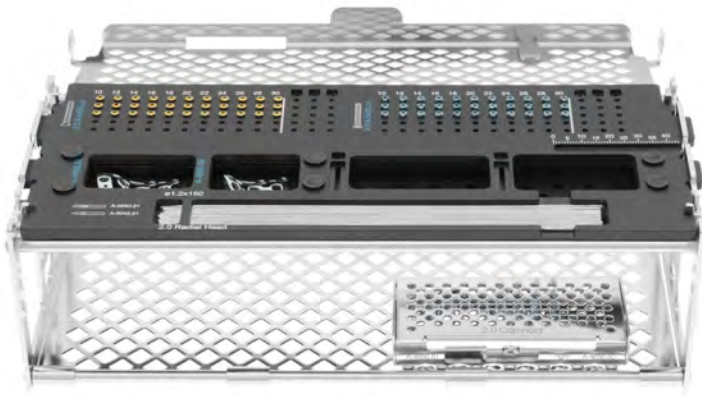

A-6530 with mounted A-6530.1  
(excl. implants)

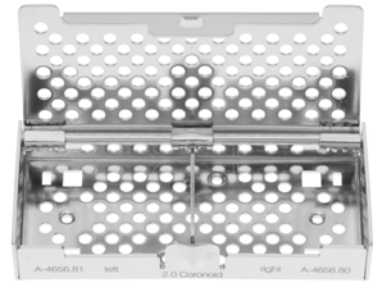

A-6530.1  
(excl. implants)

Art. No.	Description	Effective Height	Pieces / Pkg
A-6530	1/5 implant module elbow 2.0 (radial head)	72 mm	1
A-6530.1	coronoid module 2.0 for A-6530	15 mm	1
A-6580	1/5 implant module elbow 2.0 (radial head and coronoid)	72 mm	1

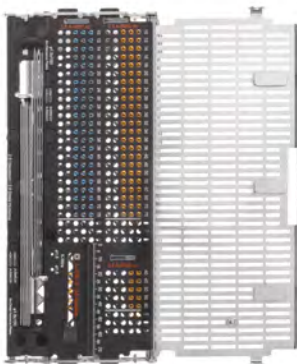

A-6533 / A-6583  
(excl. implants)



A-6537  
(excl. implants)



A-6538  
(excl. implants)

Art. No.	Description	Effective Height	Pieces / Pkg
A-6533	1/5 screw module elbow 2.8	120 mm	1
A-6537	1/5 plate module olecranon 2.8	24 mm	1
A-6538	3/5 plate module distal humerus 2.8	24 mm	1
A-6583	1/5 screw module elbow 2.8	96 mm	1



A-6531  
(excl. instruments)

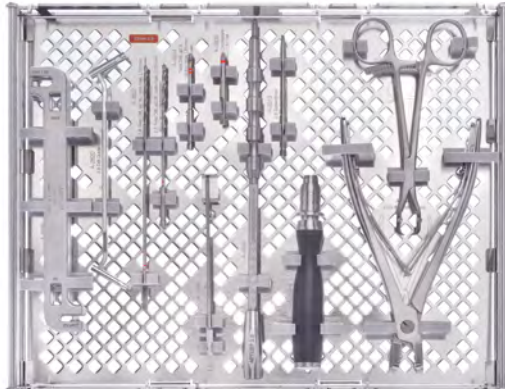

A-6534  
(excl. instruments)

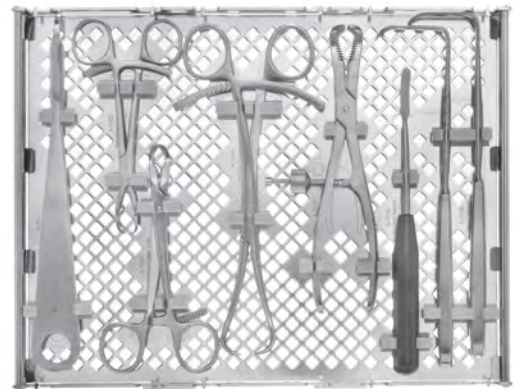

A-6535  
(excl. instruments)

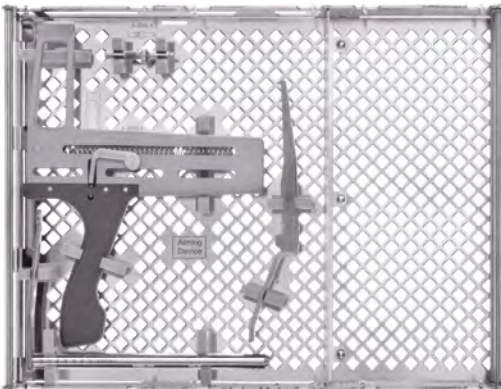

A-6536  
(excl. instruments)

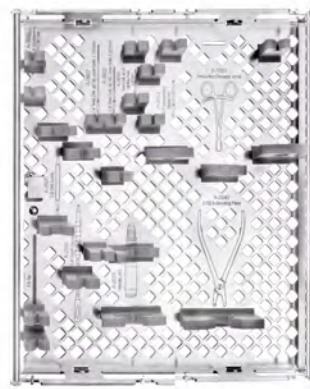

A-6585  
(excl. instruments)

Art. No.	Description	Effective Height	Pieces / Pkg
A-6531	1/5 instrument module elbow 2.0	72 mm	1
A-6534	3/5 instrument module elbow 2.0/2.8	24 mm	1
A-6535	3/5 instrument module elbow 2.8	48 mm	1
A-6536	3/5 instrument module elbow	48 mm	1
A-6585	2/5 instrument module elbow 2.8	48 mm	1

## Storage and Transportation



A-6502/A-6503

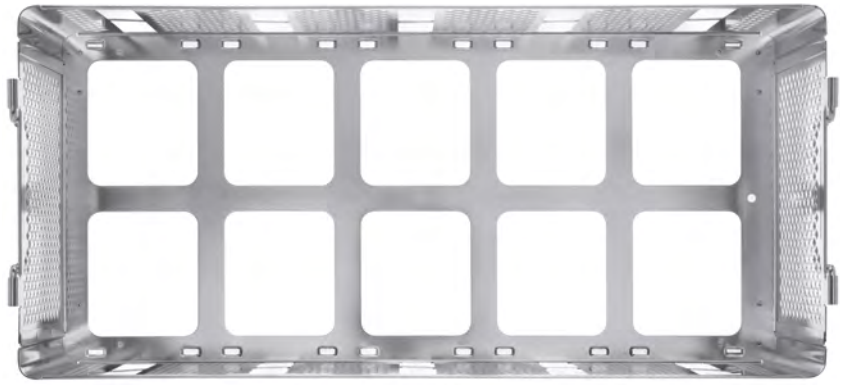

A-6505



A-6510



A-6513/A-6514

Art. No.	Description	Effective Height	Pieces / Pkg
A-6500	lid for 2/5 case		1
A-6501	lid for 5/5 case		1
A-6502	2/5 case	72 mm	1
A-6503	2/5 case	144 mm	1
A-6505	5/5 case	144 mm	1
A-6510	3/5 module spacer	24 mm	1
A-6513	1/5 module spacer	72 mm	1
A-6514	1/5 module spacer	24 mm	1

## Articles available on request

A-5045.41/1	A-5500.10	A-5500.17	A-5500.24
A-5045.41/2S	A-5500.10/1	A-5500.17/1	A-5500.24/1
A-5045.42/1	A-5500.10/1S	A-5500.17/1S	A-5500.24/1S
A-5045.42/2S	A-5500.11	A-5500.18	A-5500.26
A-5045.43/1	A-5500.11/1	A-5500.18/1	A-5500.26/1
A-5045.43/2S	A-5500.11/1S	A-5500.18/1S	A-5500.26/1S
A-5500.05	A-5500.12	A-5500.19	A-5500.28
A-5500.05/1	A-5500.12/1	A-5500.19/1	A-5500.28/1
A-5500.05/1S	A-5500.12/1S	A-5500.19/1S	A-5500.28/1S
A-5500.06	A-5500.13	A-5500.20	A-5500.30
A-5500.06/1	A-5500.13/1	A-5500.20/1	A-5500.30/1
A-5500.05/1S	A-5500.13/1S	A-5500.20/1S	A-5500.30/1S
A-5500.07	A-5500.14	A-5500.21	A-5500.32
A-5500.07/1	A-5500.14/1	A-5500.21/1	A-5500.32/1
A-5500.07/1S	A-5500.14/1S	A-5500.20/1S	A-5500.32/1S
A-5500.08	A-5500.15	A-5500.22	A-5500.34
A-5500.08/1	A-5500.15/1	A-5500.22/1	A-5500.34/1
A-5500.08/1S	A-5500.15/1S	A-5500.22/1S	A-5500.34/1S
A-5500.09	A-5500.16	A-5500.23	
A-5500.09/1	A-5500.16/1	A-5500.23/1	
A-5500.09/1S	A-5500.16/1S	A-5500.23/1S	

R\_ELBOW-01010001\_v0 / © 2021-08, Medartis AG, Switzerland. All technical data subject to alteration.

#### **MANUFACTURER & HEADQUARTERS**

Medartis AG | Hochbergerstrasse 60E | 4057 Basel / Switzerland  
P +41 61 633 34 34 | F +41 61 633 34 00 | [www.medartis.com](http://www.medartis.com)

#### **SUBSIDIARIES**

Australia | Austria | Brazil | China | France | Germany | Japan | Mexico | New Zealand | Poland | Spain | UK | USA

For detailed information regarding our subsidiaries and distributors, please visit [www.medartis.com](http://www.medartis.com)



Disclaimer: This information is intended to demonstrate the Medartis portfolio of medical devices. A surgeon must always rely on her or his own professional clinical judgement when deciding whether to use a particular product when treating a particular patient. Medartis is not giving any medical advice. The devices may not be available in all countries due to registration and / or medical practices. For further questions, please contact your Medartis representative ([www.medartis.com](http://www.medartis.com)). This information contains CE-marked products.  
For US only: Federal law restricts this device to sale by or on the order of a physician.