

medartis

PRECISION IN FIXATION

SURGICAL TECHNIQUE

Proximal Humerus System 3.5



APTUS Shoulder

Contents

| | |
|----|--|
| 3 | Introduction |
| 3 | Product Materials |
| 3 | Indications |
| 3 | Contraindications |
| 3 | Color Coding |
| 3 | Symbols |
| 4 | System Overview |
| 6 | Instrument Application |
| 6 | General Instrument Application |
| 6 | Drilling |
| 7 | Assigning the Screw Length |
| 8 | Screw Pick-Up |
| 9 | Specific Instrument Application |
| 9 | Drill Guide Blocks |
| 11 | Surgical Techniques |
| 11 | General Surgical Techniques |
| 11 | Lag Screw Technique |
| 12 | Specific Surgical Techniques |
| 12 | Proximal Humeral Plate without Spiral Blade |
| 14 | Proximal Humeral Plate with Spiral Blade |
| 22 | Explanation |
| 24 | TriLock Locking Technology |
| 24 | Correct Application of the TriLock Locking Technology |
| 25 | Correct Locking ($\pm 15^\circ$) of the TriLock Screws in the APTUS Humeral System 3.5 |
| 26 | Implants, Instruments and Containers |

For further information regarding the APTUS product line, visit www.medartis.com

Introduction

Product Materials

| Product | Material |
|---------------|--|
| Plates | Pure titanium |
| Spiral blades | Pure titanium |
| Screws | Titanium alloy |
| K-wires | Stainless steel |
| Instruments | Stainless steel, PEEK, aluminum, Nitinol, silicone or titanium |
| Containers | Stainless steel, aluminum, PEEK, polyphenylsulfone, polyurethane, silicone |

Indications

APTUS Shoulder

Fractures and osteotomies of the bones of the shoulder

- Proximal humerus plates
 - fractures, osteotomies and non-unions of the proximal humerus
- Proximal humerus XL plates
 - fractures, osteotomies and non-unions of the proximal humerus and fractures extending to the humeral shaft

Contraindications

- Preexisting or suspected infection at or near the implantation site
- Known allergies and/or hypersensitivity to implant materials
- Inferior or insufficient bone quality to securely anchor the implant
- Patients who are incapacitated and/or uncooperative during the treatment phase
- Growth plates are not to be blocked with plates and screws

Color Coding

| System Size | Color Code |
|-------------|------------|
| 3.5 | Green |

Plates, Screws and Spiral Blades

Special implant plates, screws and spiral blades have their own color:

| | |
|----------------------------|--|
| Implant plates blue | TriLock plates (locking) |
| Implant spiral blades blue | Spiral Blades Proximal Humerus |
| Implant screws gold | Cortical screws (fixation) |
| Implant screws blue | TriLock screws (locking), Screws for blade fixation |

Symbols



HexaDrive



See Instructions for Use
www.medartis.com

System Overview

The plates of the APTUS Proximal Humerus System 3.5 (A-4951.01–10) are available in five lengths and in a left and a right version.

The spiral blades are available in a 40° angle (A-4951.23–24) and a 50° angle (A-4951.21–22) and in a left and a right

version. Both options are compatible with all five plate lengths.

The spiral blade is fixed to the plate with two screws (A-4951.30).



Treatment Concept

When addressing a fracture pattern that requires additional medial support of the proximal humerus, the plate can be combined with the spiral blade 40° or the spiral blade 50°. These spiral blades provide additional support to the

plate-screw-construct in the medial bone tissue¹. In addition, the XL plate types of the system enable the management of fracture patterns that extend to the humeral shaft.

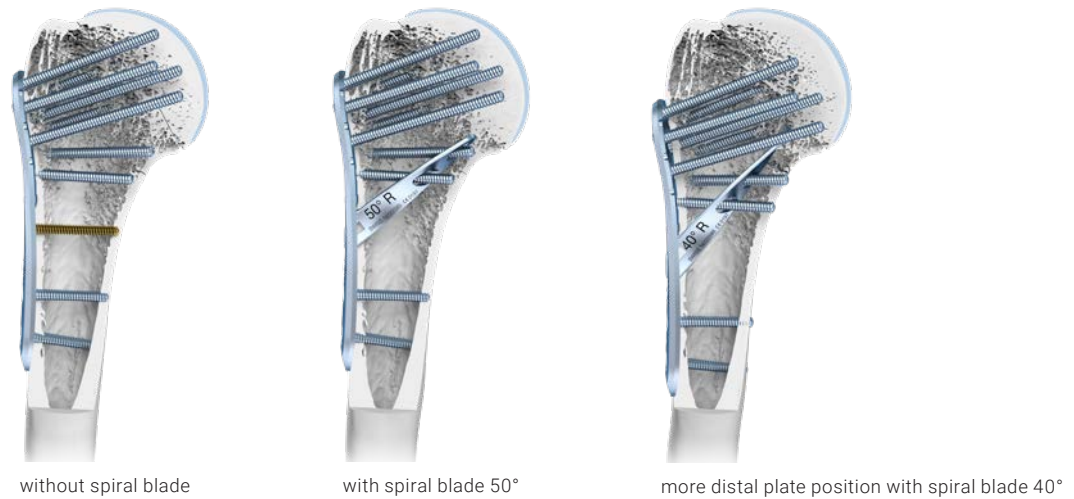

The above-mentioned information is a recommendation only. The operating surgeon is solely responsible for the choice of the suitable implant for the specific case

¹ Beirer M, Crönlein M, Venjakob AJ, Saier T, Schmitt-Sody M, Huber-Wagner S, Biberthaler P, Kirchhoff C: Additional calcar support using a blade device reduces secondary varus displacement following reconstruction of the proximal humerus: a prospective study. Eur J Med Res 2015; 20: 82

Instrument Application

General Instrument Application

Drilling

Color-coded twist drills are available for every APTUS system size. All twist drills are color-coded with a ring system.

| System Size | Color Code |
|-------------|------------|
| 3.5 | Green |

There are two different types of twist drills for every system size:

The core hole drill is characterized by one coloured ring.

The gliding hole drill (for lag screw technique and for cortex opening) is characterized by two coloured rings.



A-3931
Core hole drill Ø 3.0 mm = one colored ring



A-3933
Gliding hole drill Ø 3.6 mm = two colored rings



A-2920
3.5 Drill Guide



A-2921
3.5 Drill Sleeve, Self-Holding

Warning

The twist drill must always be guided by the drill guide (A-2920) or the self-holding drill sleeve (A-2921). This prevents damage to the screw hole and protects the surrounding tissue from direct contact with the drill.

The end with one green bar of the double-ended drill guide (A-2920) can be used for all screw holes and for the insertion of independent screws (e.g. fragment fixation with screws alone).

The self-holding drill sleeve (A-2921) can be locked with a clockwise turn in the TriLock holes of the plate (no more than $\pm 15^\circ$). It thus performs all of the functions of a drill guide without the need to be held.



Warning

For TriLock plates ensure that the screw holes are predrilled with a pivoting angle of no more than $\pm 15^\circ$. A predrilled pivoting angle of $> 15^\circ$ no longer allows the TriLock screws to correctly lock in the plate.

Assigning the Screw Length

The depth gauge (A-2930) is used to assign the ideal screw length for use in monocortical or bicortical screw fixation of TriLock screws and cortical screws.

Retract the slider of the depth gauge.

The depth gauge caliper has a hooked tip that is either inserted to the bottom of the hole or is used to catch the far cortex of the bone. When using the depth gauge, the caliper stays static, only the slider is adjusted.

To assign the screw length, place the end of the slider onto the implant plate or directly onto the bone.

When using the lag screw technique, place the end of the slider directly onto the bone (e.g. for fracture fixation with lag screws).

The ideal screw length for the assigned drill hole can be read on the scale of the depth gauge.

The required screw length may also be determined at the scale of the drill (A-3931). The length is read at the end of the drill guide (A-2920) or the self-holding drill sleeve (A-2921).



A-2930
3.5/4.0 Depth Gauge

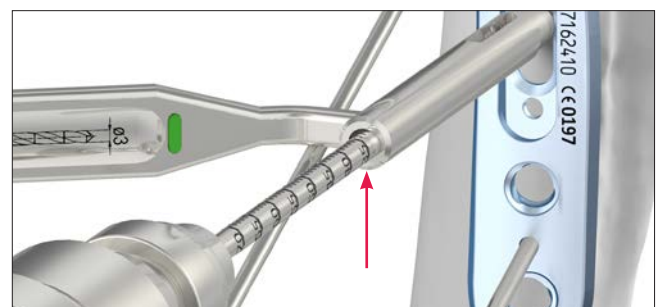
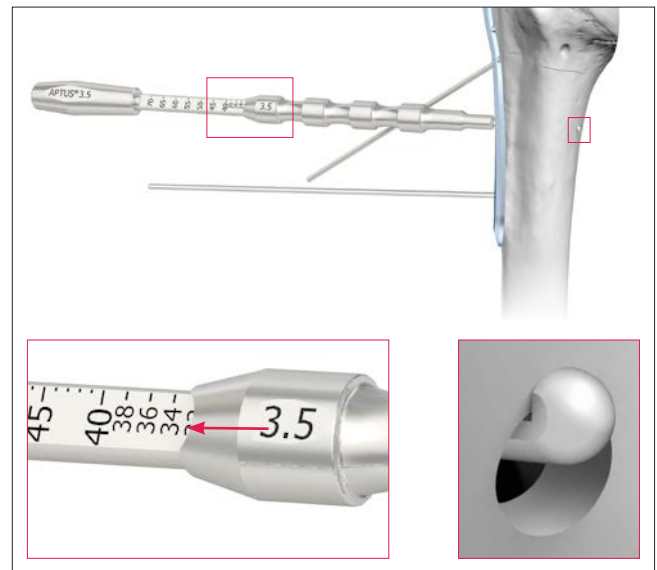

Screw Pick-Up

Both screwdriver blades (A-2911, A-2913.1) feature the patented HexaDrive self-holding system.



A-2911
3.5/4.0 Screwdriver Blade, HD15, AO, Short



A-2913.1
3.5/4.0 Screwdriver Blade, HD15, AO, Long



A-2913.2
3.5/4.0 Sleeve for Screwdriver Blade HD15 (for use with A-2913.1)



A-2074
Handle with Quick Connector, AO



A-2075
T-Handle with Quick Connector, AO

To remove the screws from the implant container, insert the appropriately color-coded screwdriver blade perpendicularly into the screw head of the desired screw and pick up the screw with axial pressure.

Notice

The screw will not hold without axial pressure.

Caution

Vertically extract the screw from the compartment. Picking up the screw repeatedly may lead to permanent deformation of the self-retaining area of the HexaDrive inside the screw head. Therefore, the screw may no longer be able to be picked up correctly. In this case, a new screw has to be used.

Notice

Check the screw length and diameter at the scale of the measuring module. The screw length is determined at the end of the screw head.

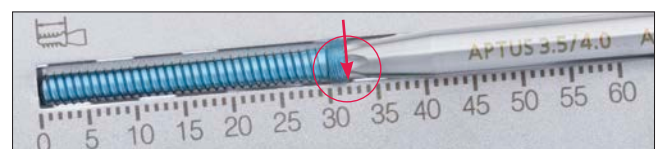

Specific Instrument Application

Drill Guide Blocks

The drill guide blocks (A-2923.01 for left plates and A-2923.02 for right plates) serve to rapidly and accurately position the proximal screws and act as a target guide for the screws which cross the spiral blade. There is no danger

of drill channels crossing during the drilling process. The corresponding axial angles* of the locking holes in the proximal area are shown in the illustration.

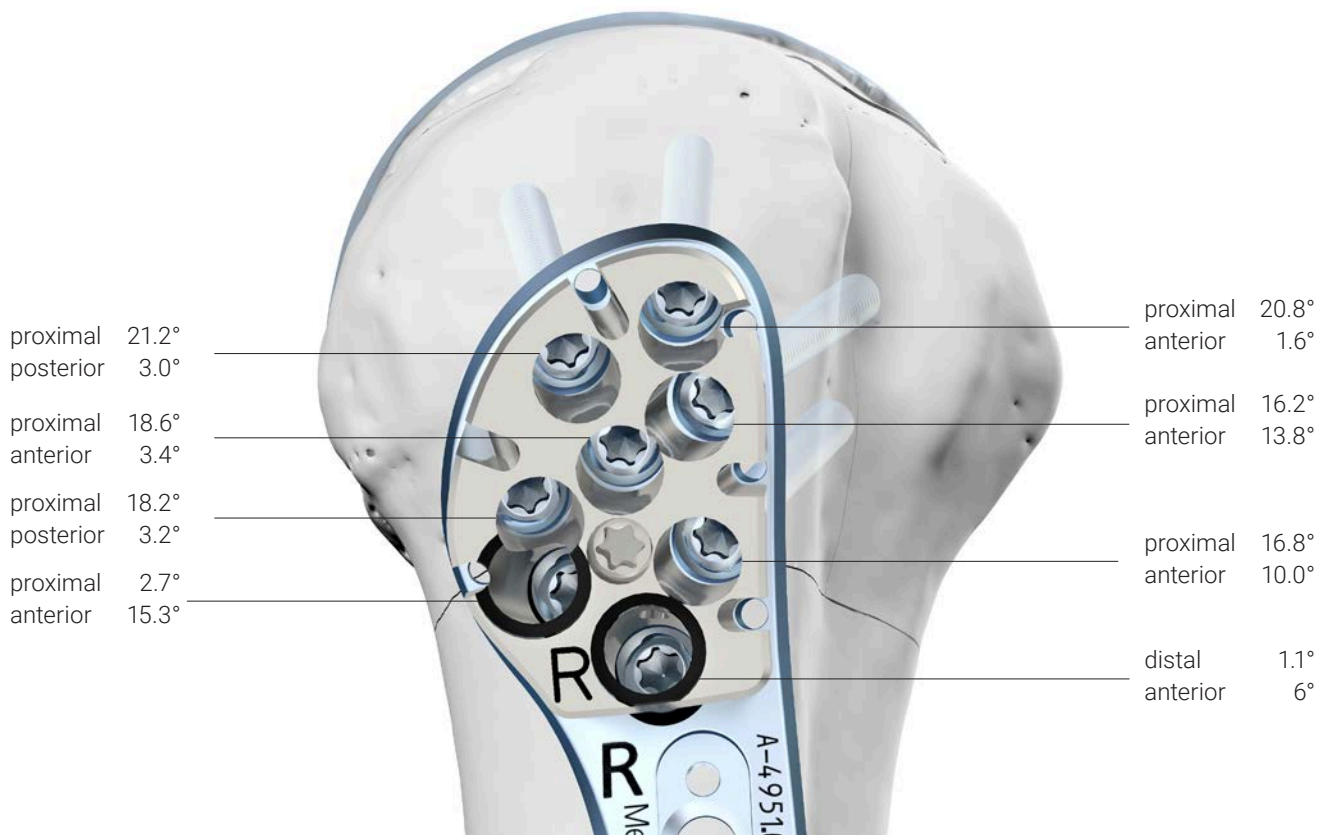

The drill guide blocks are adapted to the proximal plate area. They are marked with R and L for the right and the left side respectively.

The screw holes for the two screws passing through the spiral blade are both marked with a black ring on the drill guide block. If a spiral blade is used, the spiral blade must be placed before inserting the two screws.

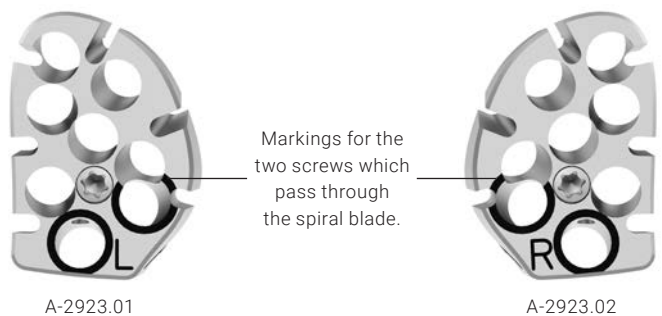

* The axial angles relate to the oblong hole plane.

The drill guide (A-2920) or the drill sleeve (A-2921), the depth gauge (A-2930) as well as the proximal K-wire (A-5040.61, A-5042.61) can be used together with the drill guide block. You can drill, measure and insert the screws through the holes of the attached drill guide block.

Caution

For screw insertion through the drill guide block, the long screwdriver blade (A-2913.1) in combination with the sleeve (A-2913.2) must be used. This ensures that the screws are guided precisely and follow the predrilled core hole even in case of osteoporotic bone.



The recesses in the drill guide block allow for making use of the suture holes even when the drill guide block is fixed to the plate.

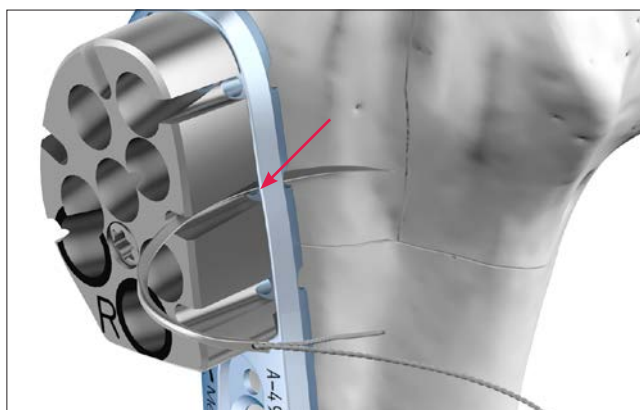

Fixing and detaching the drill guide block

Position the drill guide block in the proximal plate area so that the three positioning aids on its underside noticeably engage to the plate surface. Take care not to trap any soft tissue between the plate and the drill guide block. Use the screwdriver (A-2911, A-2913.1) to fully tighten the screw integrated in the drill guide block until there is no play between the plate and the drill guide block.

During the insertion of the spiral blade, the drill guide can remain attached to the plate. Once all screws in the proximal plate area have been fixated, the drill guide block can be detached.

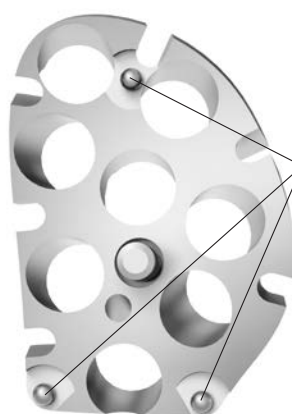

Positioning aids for the drill guide block

Surgical Techniques

General Surgical Techniques

Lag Screw Technique

Warning

Incorrect application of the lag screw technique may result in postoperative loss of reduction.

1. Drilling the gliding hole

Drill the gliding hole using the twist drill marked with two green rings (A-3933, Ø 3.6 mm) in combination with the end of the drill guide (A-2920) labeled with "LAG". Drill perpendicular to the fracture line.

Do not drill further than to the fracture line.



2. Drilling the core hole

Insert the other end of the drill guide (A-2920) into the drilled gliding hole and use the twist drill for core holes with one green ring (A-3931, Ø 3.0 mm) to drill the core hole.



3. Compressing the fracture

Compress the fracture with the corresponding cortical screw.

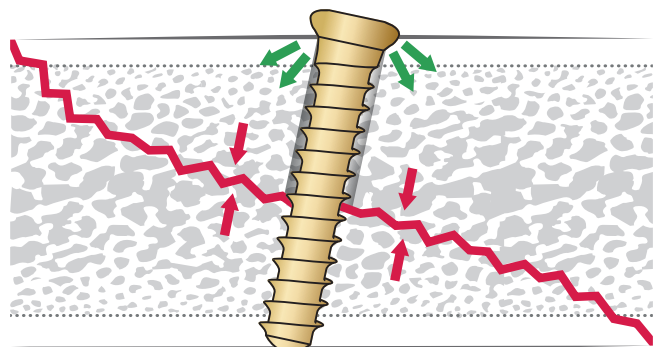

Specific Surgical Techniques

Proximal Humeral Plate without Spiral Blade

1. Positioning the plate

After reduction of the fracture, the humeral plate (A-4951.01–10) can be fixed temporarily with 2.0 mm K-wires (A-5040.61, A-5042.61) in the desired position.

The course of the sulcus intertubercularis may be used as orientation for positioning the anterior plate edge. The plate has an anatomical fit and comes to rest approx. 5–10 mm distally of the top of the greater tubercle.

Caution

Placing the plate too proximally increases the risk of a subacromial impingement. If the plate is placed too distally, the optimal screw positioning in the humeral head may be more difficult.

Use intraoperative X-ray control to verify the correct plate position.

2. Fixation of the plate

Start the fixation with a golden cortical screw (A-5900.xx) in the oblong hole. Drill, assign the screw length and insert the screw.

If the plate position needs adjustment: remove all K-wires in the fragment to be adjusted, slightly loosen the cortical screw in the oblong hole, readjust the position of the plate and retighten the cortical screw.

Insert a golden 3.5 mm cortical screw (A-5900.xx) into the center of the oblong hole. To this end, drill a core hole through the oblong hole using the drill guide (A-2920) and the twist drill \varnothing 3.0 mm (A-3931, one colored ring).

Assign the screw length with the depth gauge (A-2930).

Pick up a cortical screw of the determined length with the help of the screwdriver blade (A-2911, A-2913.1) as well as the handle (A-2074, A-2075) and insert it into the corresponding hole.



3. Fixation of the plate

Fill the remaining screw holes preferably with blue TriLock screws (A-5950.xx) or with golden cortical screws (A-5900.xx) wherever indicated by the fracture pattern and remove the remaining K-wires. All screw holes with the exception of the oblong hole accept both cortical as well as TriLock screws.

Warning

The T-handle (A-2075) must always be used to lock 3.5 TriLock screws.



The choice of angular stable screws generally provides a higher stability of the construct, especially in case of a comminuted fracture or poor bone quality. The choice of non angular stable screws (cortical screws) permits to pull a fragment to the plate.

The multidirectionality of the locked ($\pm 15^\circ$) and unlocked screws allows to individually address each fragment.

Warning

When inserting the screws without using the drill guide block, care must be taken that the drilling channels do not cross. If the free choice of the angle of the TriLock screws in the proximal area is not necessary, the drill guide block (A-2923.01 left, A-2923.02 right) can be used. The drill guide block allows a fast and unidirectional insertion of the screws.



4. Attachment of soft tissue

Soft tissue or bone fragments can be attached to the plate using sutures that pass through the suture holes provided in the plate.

Proximal Humeral Plate with Spiral Blade

1. Fixing the drill guide block

Place the drill guide block (A-2923.01 left, A-2923.02 right) on the humeral plate (A-4951.01–10) so that the three positioning aids on its underside noticeably engage with the plate surface. Use the screwdriver (screwdriver blade A-2911 with handle A-2074) to finger tighten the screw integrated in the drill guide block until there is no play between the plate and the drill guide block.

Notice

If the drill guide block is mounted onto the plate when the plate is already positioned on the bone, ensure that no soft tissue is trapped between the plate and the drill guide block and that the drill guide block is correctly aligned.

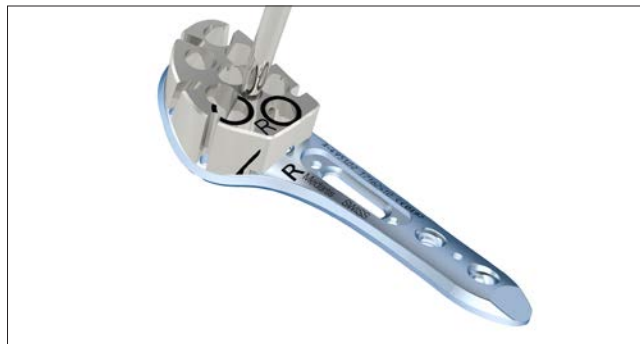

2. Positioning the plate

After reduction of the fracture, the plate can be fixed temporarily with 2.0 mm K-wires (A-5040.61, A-5042.61) in the desired position. The course of the sulcus intertubercularis may be used as orientation for positioning the anterior plate edge. The plate has an anatomical fit and comes to rest approx. 5–10 mm distally of the top of the greater tubercle.

Caution

Placing the plate too proximally increases the risk of a subacromial impingement. If the plate is placed too distally, the optimal screw positioning in the humeral head may be more difficult.

Use intraoperative X-ray control to verify the correct plate position.

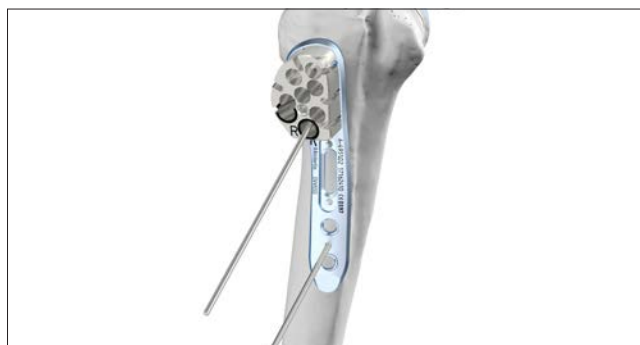

2. Initial fixation of the plate

Start the fixation with a golden cortical screw (A-5900.xx) in the oblong hole. Drill, assign the screw length and insert the screw.

If the plate position needs adjustment: remove all K-wires in the fragment to be adjusted, slightly loosen the cortical screw in the oblong hole, readjust the position of the plate and retighten the cortical screw.

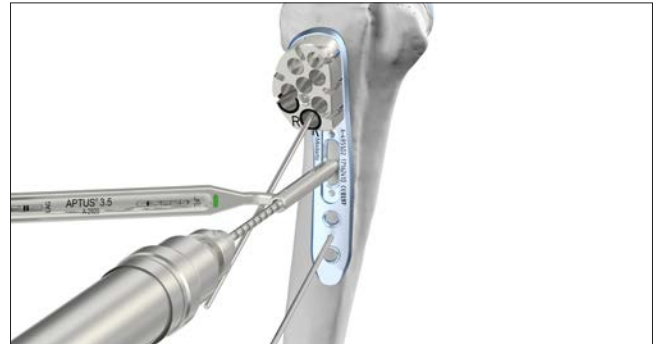

Fixate the plate with at least two blue TriLock screws (A-5950.xx) in the shaft as well as in the proximal area. All screw holes with the exception of the oblong hole accept both golden cortical and blue TriLock screws.

Caution

At the current stage, the screw holes with the black ring on the drill guide block must not yet be filled. The screws in these screw holes pass through the spiral blade and can only be inserted after the spiral blade has been placed.

Warning

The T-handle (A-2075) must always be used to lock 3.5 TriLock screws.

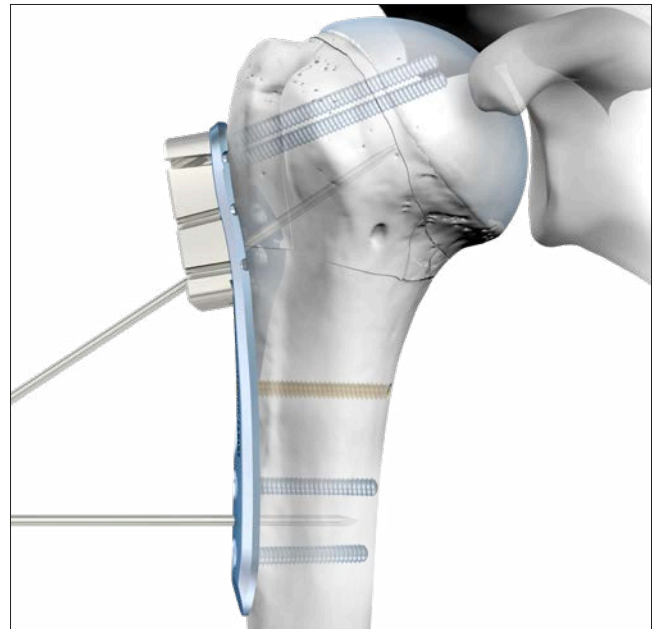

Caution

Always use the sleeve (A-2913.2) to insert the screws into the drill guide block.

The sleeve on the screwdriver blade (A-2913.1) ensures that the screws are guided precisely and follow the predrilled core hole even in case of osteoporotic bone.

Insert the sleeve with the smooth end pointing to the plate completely into the drill guide block. Use the long screwdriver blade to insert the screws up to the black marking through the sleeve. Remove the sleeve and lock the screw under visual control.





A-2000
K-wire guide Ø 2.0 mm

4. Determining the angle of the spiral blade

Remove the K-wires and the cortical screw in the oblong hole. Insert the K-wire guide (A-2000) either with the 40° or 50° side into the oblong hole by first hooking the nose on the K-wire guide under the distal part of the oblong hole and then inserting the entire K-wire guide into the oblong hole.

Notice

Any instrument that is placed into the oblong hole must completely snap in and rest flat in the oblong hole. Make sure that no soft tissue gets trapped under the instrument. Not completely inserting the instrument may result in a wrong guidance of the direction of the spiral blade.

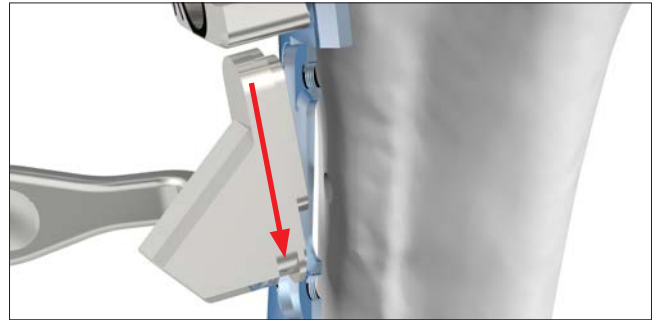

Place a 2.0 mm K-wire through the K-wire guide (A-2000). This K-wire indicates the position where the spiral blade will be situated later. The tip of the K-wire should lie close to the inferomedial cortex of the humeral head. Check this position on an anteroposterior X-ray.

If the position is not optimal, remove the K-wire and repeat the step with the other end of the K-wire guide for the alternative spiral blade angle.

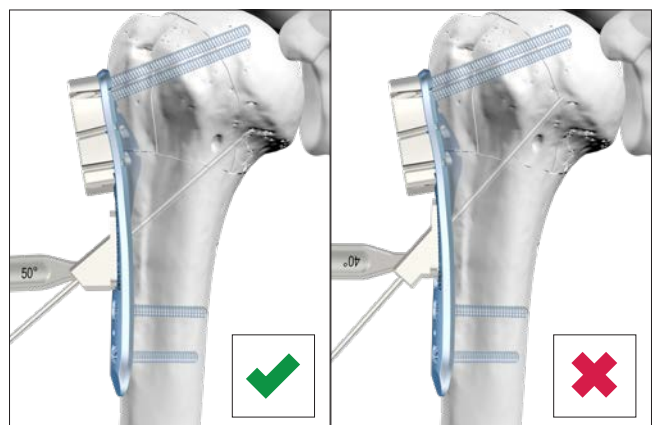



A-2924
Drill guide for cortex opening for spiral blade

5. Opening of the cortex

The cortex in the oblong hole has to be opened in order to enable the insertion of the spiral blade.

Remove the K-wire and the K-wire guide from the oblong hole and insert the drill guide for cortex opening (A-2924) into the oblong hole.

Notice

Any instrument that is placed into the oblong hole must completely snap in and rest flat in the oblong hole. Make sure that no soft tissue gets trapped under the instrument. Not completely inserting the instrument may result in a wrong guidance of the direction of the spiral blade.

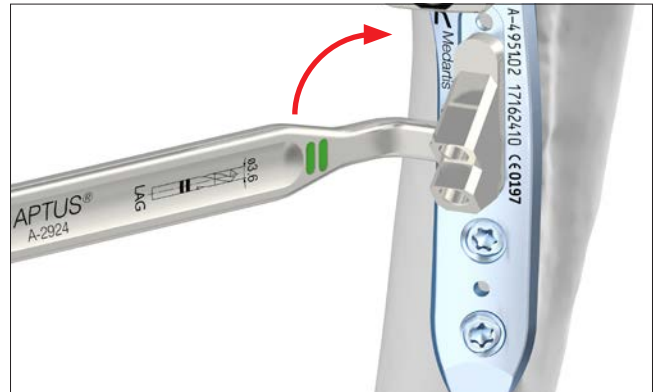

Drill two short holes through both holes of the drill guide using the twist drill (A-3933, two green rings). Only pass the first cortex. Repeat this procedure with the other end of the drill guide. Remove the drill guide for cortex opening. The four overlapping holes enable to cut a spiral channel into the bone in order to insert the spiral blade.

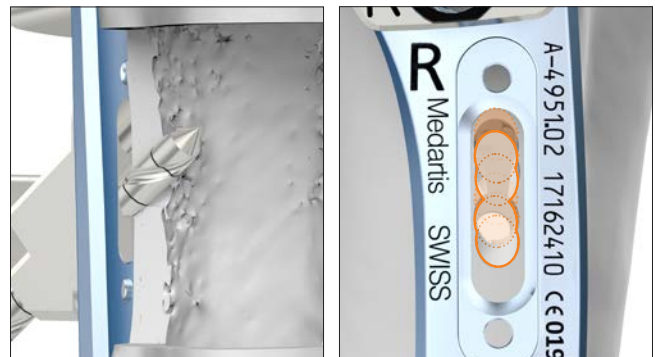

A-2001.01 A-2001.02
Left and right guide for spiral cutters for 50° spiral blade



A-2001.03 A-2001.04
Left and right guide for spiral cutters for 40° spiral blade

6. Cutting the spiral channel

As the spiral blade has a blunt end, a spiral channel has to be cut into the bone beforehand, using the spiral cutter for blade (A-2002.01 for left plates, A-2002.02 for right plates). To this end, insert the guide for spiral cutter for the chosen blade angle (A-2001.01/03 for left plates or A-2001.02/04 for right plates) into the oblong hole. Tighten the integrated screw using the screwdriver blade (A-2911, A-2913.1) and the handle (A-2074).

Notice

Any instrument that is placed into the oblong hole must completely snap in and rest flat in the oblong hole. Make sure that no soft tissue gets trapped under the instrument. Not completely inserting the instrument may result in a wrong guidance of the direction of the spiral blade.



A-2002.01
Spiral cutter for left spiral blades



A-2002.02
Spiral cutter for right spiral blades



A-2003
Handle for spiral blade cutters and spiral blades



A-2004
Mallet, slotted

Place the spiral cutter for blade into the guide fixed to the plate and carefully tap it in up to the stop with the mallet (A-2004).

To facilitate the handling, you may screw the handle for spiral blade (A-2003) on the spiral cutter.

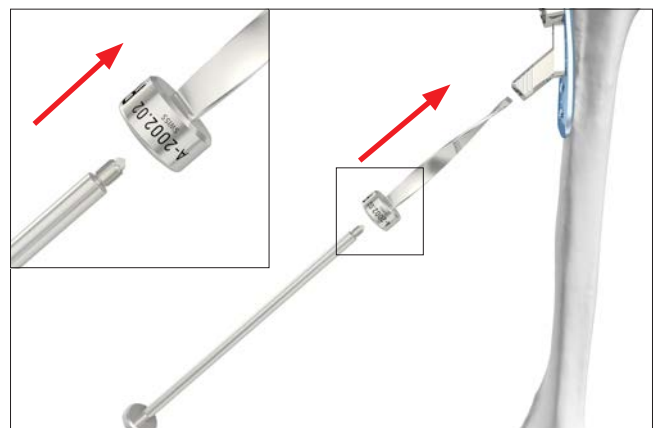

Remove the spiral cutter using the handle for spiral blade (A-2003) and the slotted mallet (A-2004). Remove the guide for spiral cutter.

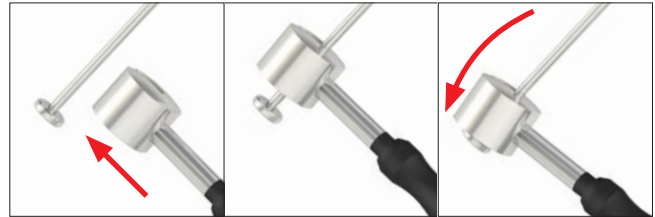

7. Inserting the spiral blade

Screw the handle (A-2003) onto the adequate spiral blade (A-4951.21/23 for left plates or A-4951.22/24 for right plates) to pick it up from the container.



The spiral blade can be inserted manually with applying slight pressure into the pre-cut channel. During the insertion, the spiral blade rotates clockwise for right plates and counter-clockwise for left plates. If necessary, carefully tap it in with the mallet (A-2004).

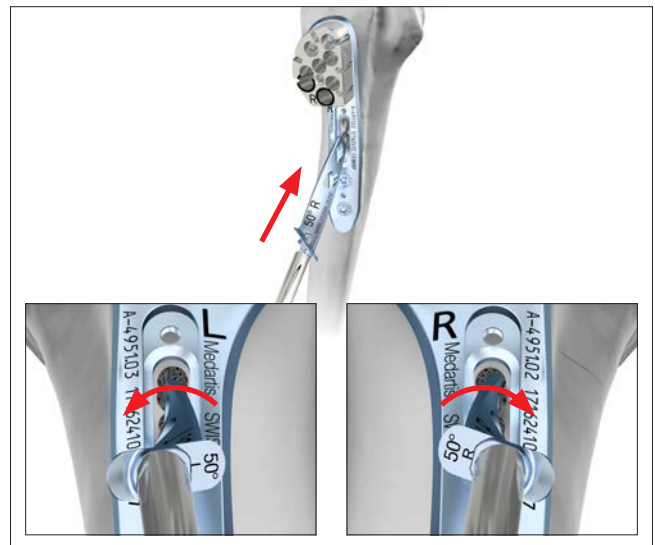

Warning

The spiral blade must be flush with the oblong hole.



Remove the handle.

Fixate the spiral blade with two screws for spiral blade (A-4951.30) to the plate. Start with the distal screw.

Warning

The two screws for fixation of the spiral blade can only be inserted if the spiral blade is flush with the oblong hole.



The plate-spiral blade-construct is additionally stabilized with two blue TriLock screws that pass through the two recesses in the spiral blade. The corresponding screw holes are indicated with two rings on the drill guide block and on the plate.



Drill, assign the screw length and insert a blue TriLock screw (A-5850.xx) in each of two marked screw holes using the screwdriver blade (A-2913.1) and the sleeve (A-2913.2).

Caution

The two screws that pass through the spiral blade always need to be placed with the drill guide block.



For these two screws and dependent on the chosen angle of the spiral blade, use the minimal screw lengths as indicated.

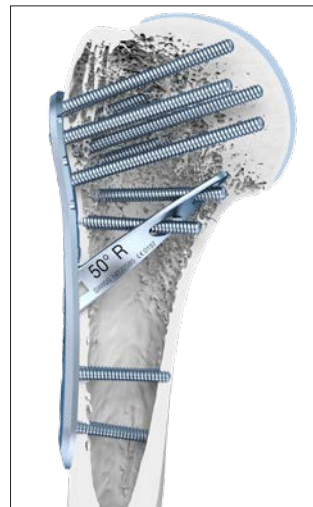

with spiral blade 50°

Proximal screw: at least 36 mm
(A-5950.36/1)
Distal screw: at least 26 mm
(A-5950.26/1)

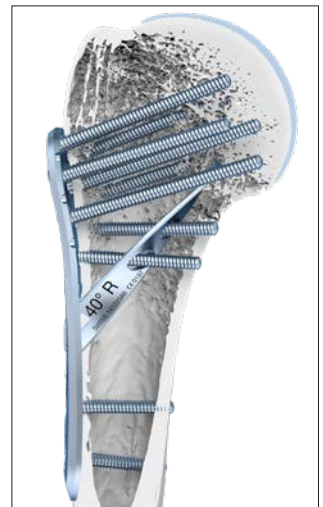

with spiral blade 40°

Proximal screw: at least 28 mm
(A-5950.28/1)
Distal screw: at least 22 mm
(A-5950.22/1)

8. Filling the remaining screw holes

Fill the remaining screw holes preferably with blue TriLock screws (A-5950.xx) or golden cortical screws (A-5900.xx) as indicated by the fracture. All screw holes accept cortical screws as well as TriLock screws. The remaining screws may be inserted without drill guide block if multidirectionality is desired in the proximal plate area.

Caution

When using the spiral blade 40° without the drill guide block, ensure that the screws highlighted in color in the image are inserted divergently. Otherwise there is a danger of a collision with the spiral blade in the marked area.

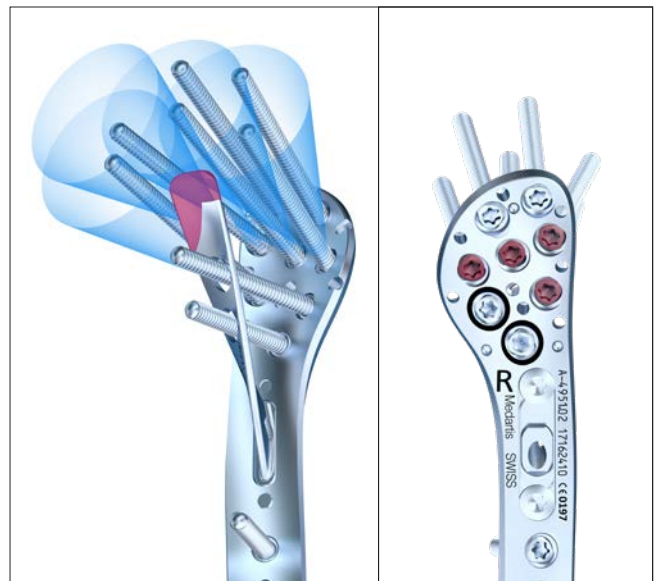

9. Attaching soft tissue

Soft tissue or bone fragments can be attached to the plate by passing sutures through the suture holes provided in the plate.

Remove the drill guide block.



Explantation

1. Removing the screws passing through the spiral blade

If a spiral blade was used, it is important to first remove the two screws passing through the recesses in the spiral blade. Use the screwdriver blade (A-2911, A-2913.1) together with the handle (A-2074, A-2075). The two screws are both marked with a ring around the screw hole.

Caution

When removing the screws, ensure that any bone ingrowth in the screw head has been removed, that the screwdriver/screw head connection is aligned in axial direction, and that a sufficient axial force is used between screwdriver blade and screw.

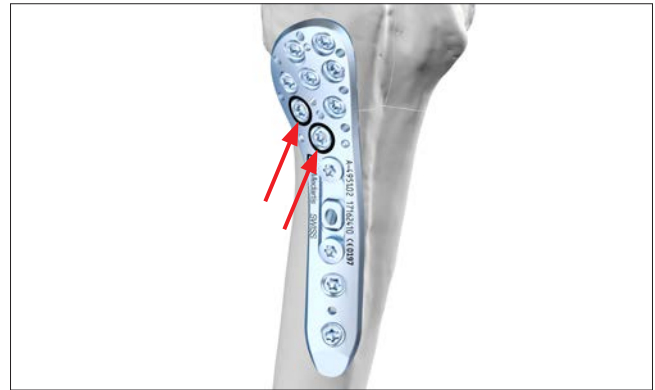

2. Removing the screws fixating the spiral blade

Afterwards remove the two screws (A-4951.30) which fixate the spiral blade to the plate.



3. Removing the spiral blade

Insert the handle for spiral blade (A-2003) into the spiral blade.



Extract the spiral blade. If necessary, carefully tap with the slotted mallet (A-2004) away from the bone against the metallic disc on the rear part of the handle (A-2003).

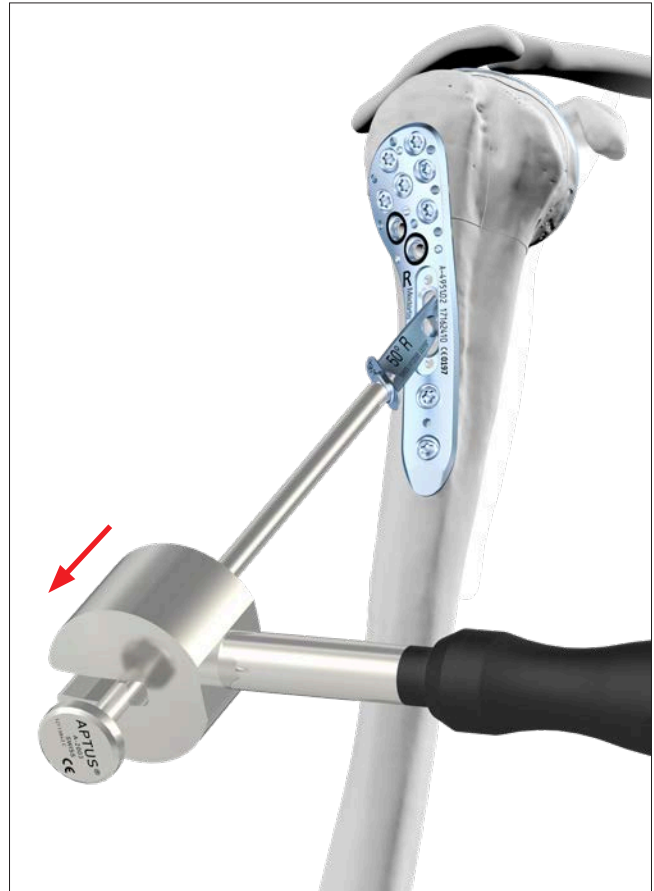

4. Removing the remaining screws

Unlock all remaining screws. Now remove the unlocked screws in random order. In case the plate sticks to the bone, use a periosteal elevator to carefully lift and detach it from the bone.

TriLock Locking Technology

Correct Application of the TriLock Locking Technology

The screw is inserted through the plate hole into the predrilled bone. A "contact torque" will be felt once the screw head makes contact with the plate surface; for the TriLock 3.5 Proximal Humerus System this torque increase is easily perceived (section "A" in the diagram).

The torque then decreases before it starts increasing again during the "Insertion Phase", as the screw head enters the locking hole (section "B" in the diagram).

Once the screw head has entered the locking hole, a second decrease of torque occurs (section "C" in the diagram).

Finally, the actual locking is initiated (section "D" in the diagram) as a friction connection is established between screw and plate when tightening firmly. The torque applied in section "D" is decisive for the quality of the locking.

In summary, two intermediate torque maxima have to be overcome before the final locking of the screw.

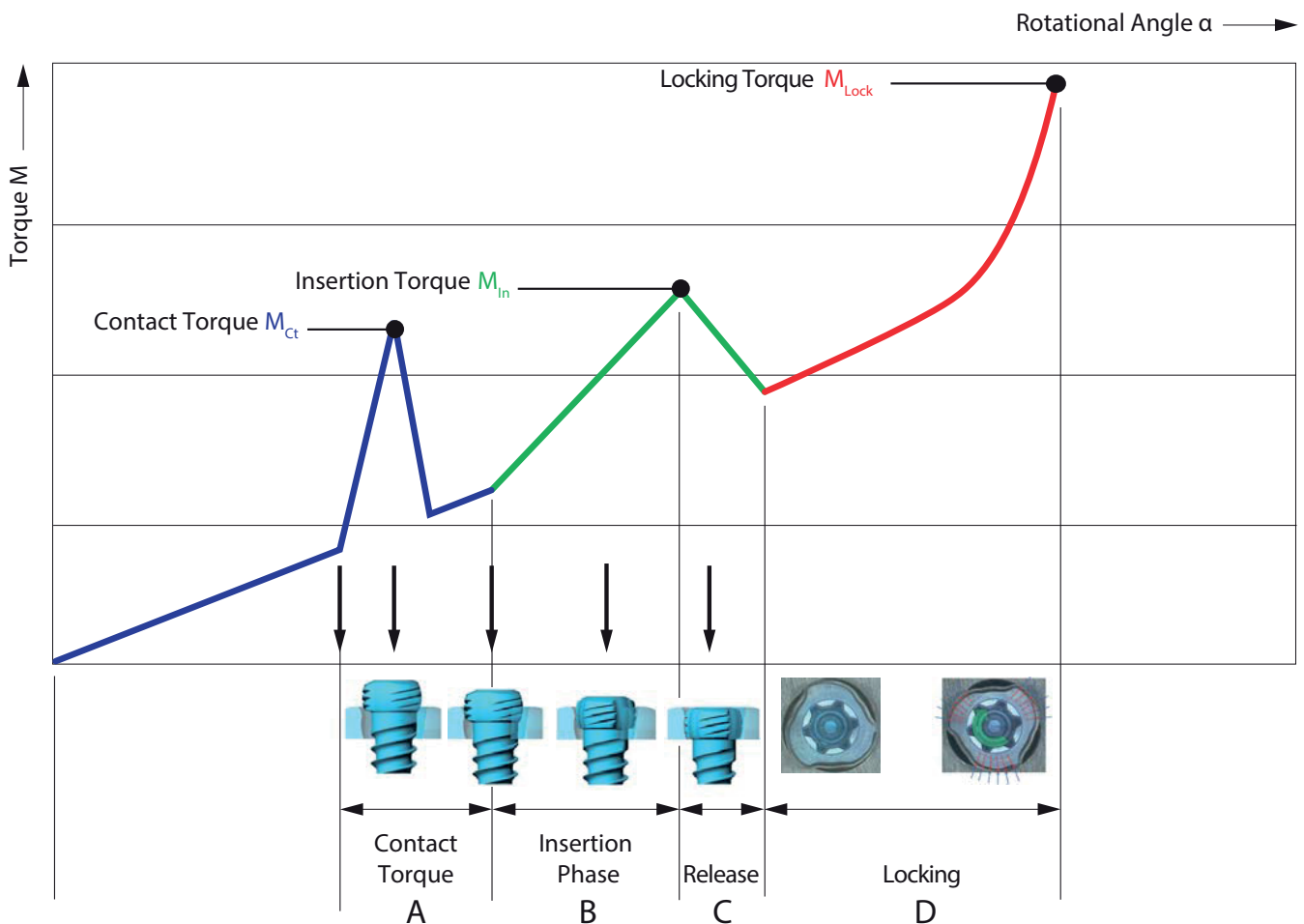

Correct Locking ($\pm 15^\circ$) of the TriLock Screws in the APTUS Proximal Humerus System 3.5

Correct locking occurs only when the screw head is locked flush with the locking contour (fig. 1 and 3).

However, if there is still a noticeable protrusion (fig. 2 and 4), the screw head has not completely reached the locking position. In this case, the screw has to be retightened to obtain full penetration and proper locking. In case of poor

bone quality a slight axial pressure may be necessary to achieve proper locking.

After having reached the locking torque (M_{Lock}), do not further tighten the screw, otherwise the locking function cannot be guaranteed anymore.

Correct: LOCKED

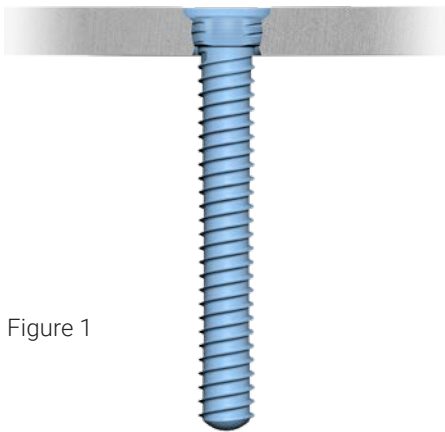

Figure 1

Incorrect: UNLOCKED

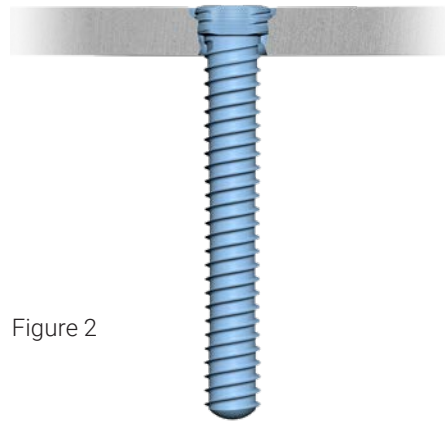

Figure 2

Correct: LOCKED

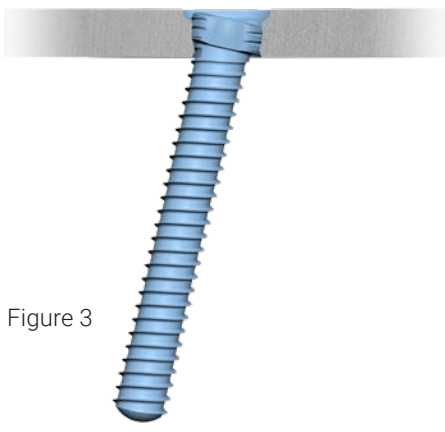

Figure 3

Incorrect: UNLOCKED

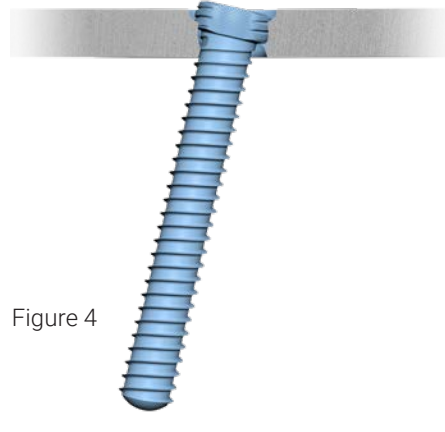

Figure 4

Implants, Instruments and Containers

3.5 Cortical Screws, HexaDrive 15

Material: Titanium alloy (ASTM F136)



| Length | Art. No. | STERILE | Pieces / Pkg |
|--------|-------------|--------------|--------------|
| 16 mm | A-5900.16/1 | A-5900.16/1S | 1 |
| 18 mm | A-5900.18/1 | A-5900.18/1S | 1 |
| 20 mm | A-5900.20/1 | A-5900.20/1S | 1 |
| 22 mm | A-5900.22/1 | A-5900.22/1S | 1 |
| 24 mm | A-5900.24/1 | A-5900.24/1S | 1 |
| 26 mm | A-5900.26/1 | A-5900.26/1S | 1 |
| 28 mm | A-5900.28/1 | A-5900.28/1S | 1 |
| 30 mm | A-5900.30/1 | A-5900.30/1S | 1 |
| 32 mm | A-5900.32/1 | A-5900.32/1S | 1 |
| 34 mm | A-5900.34/1 | A-5900.34/1S | 1 |
| 36 mm | A-5900.36/1 | A-5900.36/1S | 1 |
| 38 mm | A-5900.38/1 | A-5900.38/1S | 1 |
| 40 mm | A-5900.40/1 | A-5900.40/1S | 1 |
| 45 mm | A-5900.45/1 | A-5900.45/1S | 1 |
| 50 mm | A-5900.50/1 | A-5900.50/1S | 1 |
| 55 mm | A-5900.55/1 | A-5900.55/1S | 1 |
| 60 mm | A-5900.60/1 | A-5900.60/1S | 1 |

3.5 TriLock Screws, HexaDrive 15

Material: Titanium alloy (ASTM F136)

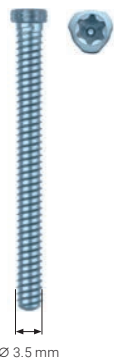

| Length | Art. No. | STERILE | Pieces / Pkg |
|--------|-------------|--------------|--------------|
| 16 mm | A-5950.16/1 | A-5950.16/1S | 1 |
| 18 mm | A-5950.18/1 | A-5950.18/1S | 1 |
| 20 mm | A-5950.20/1 | A-5950.20/1S | 1 |
| 22 mm | A-5950.22/1 | A-5950.22/1S | 1 |
| 24 mm | A-5950.24/1 | A-5950.24/1S | 1 |
| 26 mm | A-5950.26/1 | A-5950.26/1S | 1 |
| 28 mm | A-5950.28/1 | A-5950.28/1S | 1 |
| 30 mm | A-5950.30/1 | A-5950.30/1S | 1 |
| 32 mm | A-5950.32/1 | A-5950.32/1S | 1 |
| 34 mm | A-5950.34/1 | A-5950.34/1S | 1 |
| 36 mm | A-5950.36/1 | A-5950.36/1S | 1 |
| 38 mm | A-5950.38/1 | A-5950.38/1S | 1 |
| 40 mm | A-5950.40/1 | A-5950.40/1S | 1 |
| 42 mm | A-5950.42/1 | A-5950.42/1S | 1 |
| 44 mm | A-5950.44/1 | A-5950.44/1S | 1 |
| 45 mm | A-5950.45/1 | A-5950.45/1S | 1 |
| 46 mm | A-5950.46/1 | A-5950.46/1S | 1 |
| 48 mm | A-5950.48/1 | A-5950.48/1S | 1 |
| 50 mm | A-5950.50/1 | A-5950.50/1S | 1 |
| 55 mm | A-5950.55/1 | A-5950.55/1S | 1 |
| 60 mm | A-5950.60/1 | A-5950.60/1S | 1 |

Spiral Blades

Material: Titanium (ASTM F67)

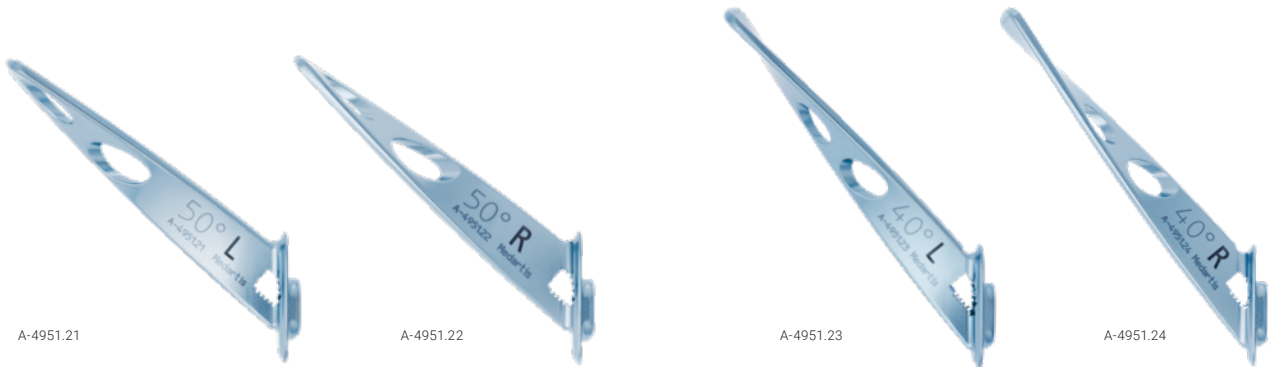

| Art. No. | STERILE | Description | Pieces / Pkg |
|-----------|------------|-------------|--------------|
| A-4951.21 | A-4951.21S | left, 50° | 1 |
| A-4951.22 | A-4951.22S | right, 50° | 1 |
| A-4951.23 | A-4951.23S | left, 40° | 1 |
| A-4951.24 | A-4951.24S | right, 40° | 1 |

Screw for Spiral Blades

Material: Titanium alloy (ASTM F136)



| Art. No. | STERILE | Pieces / Pkg |
|-----------|--------------|--------------|
| A-4951.30 | | 1 |
| | A-4951.30/2S | 2 |

3.5 TriLock Proximal Humeral Plates

Material: Titanium (ASTM F67)
Plate thickness: 3.0 mm

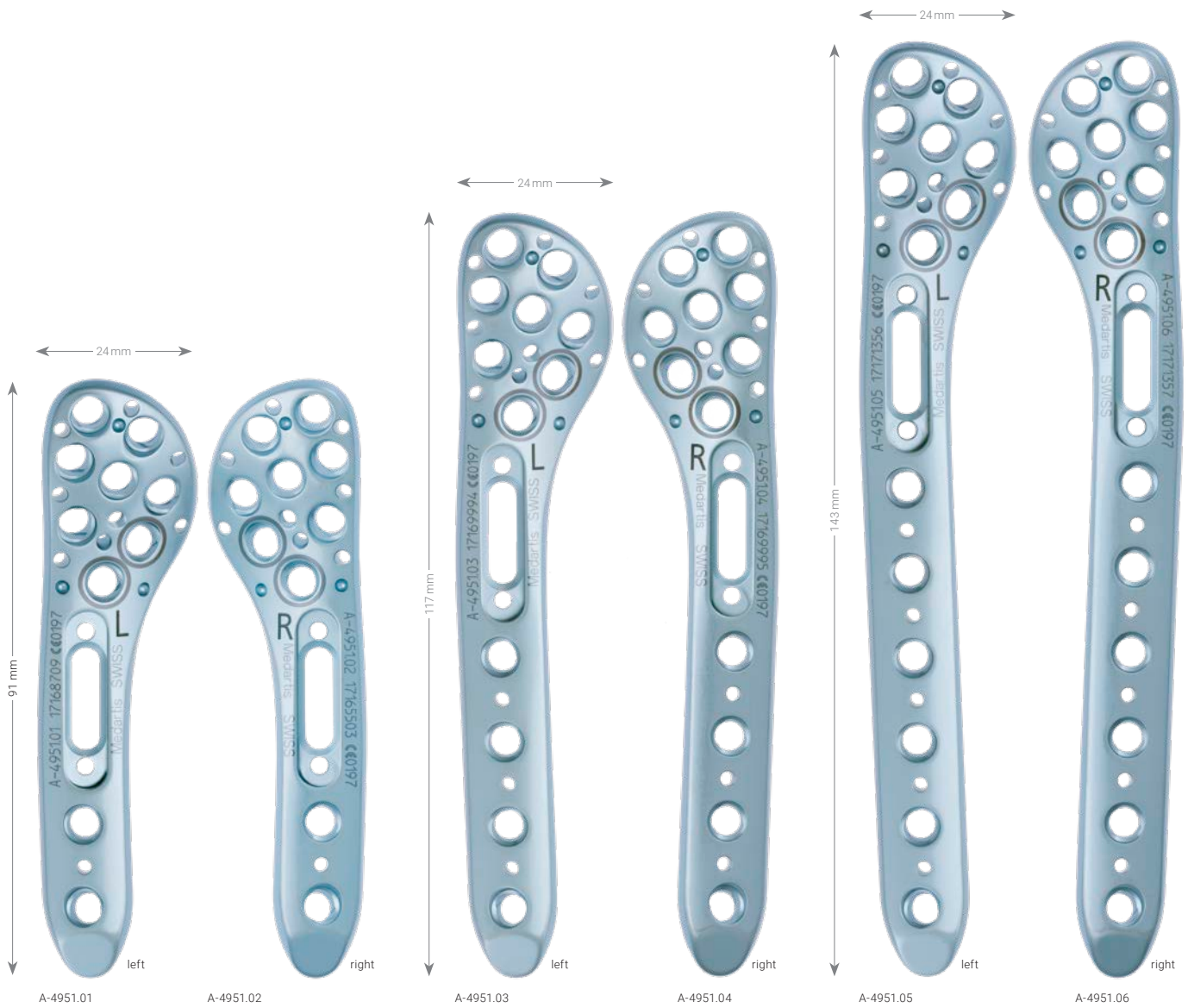

| Art. No. | STERILE | Description | Holes | Pieces / Pkg |
|-----------|------------|-------------|-------|--------------|
| A-4951.01 | A-4951.01S | left | 3 | 1 |
| A-4951.02 | A-4951.02S | right | 3 | 1 |
| A-4951.03 | A-4951.03S | left | 5 | 1 |
| A-4951.04 | A-4951.04S | right | 5 | 1 |
| A-4951.05 | A-4951.05S | left | 7 | 1 |
| A-4951.06 | A-4951.06S | right | 7 | 1 |

3.5 TriLock Proximal Humeral Plates, XL

Material: Titanium (ASTM F67)
Plate thickness 3.0–3.8 mm

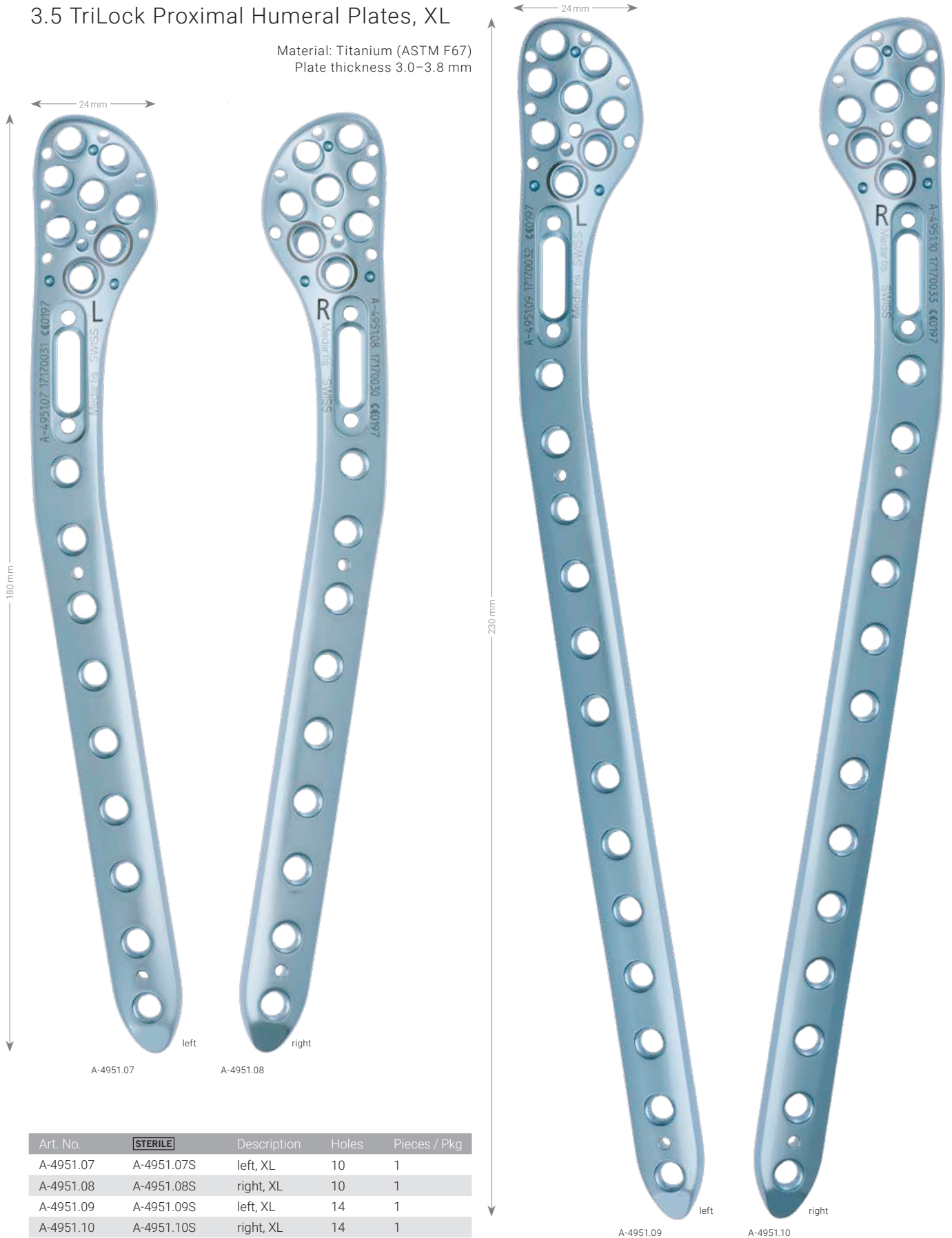

| Art. No. | STERILE | Description | Holes | Pieces / Pkg |
|-----------|------------|-------------|-------|--------------|
| A-4951.07 | A-4951.07S | left, XL | 10 | 1 |
| A-4951.08 | A-4951.08S | right, XL | 10 | 1 |
| A-4951.09 | A-4951.09S | left, XL | 14 | 1 |
| A-4951.10 | A-4951.10S | right, XL | 14 | 1 |

Drill Guide Blocks (incl. Screw)



A-2923.01

A-2923.02

| Art. No. | Description | Pieces / Pkg |
|-----------|------------------------------|--------------|
| A-2923.01 | left | 1 |
| A-2923.02 | right | 1 |
| A-2923.03 | screw for drill guide blocks | 1 |

Spiral Cutters for Blades



A-2002.01



A-2002.02

| Art. No. | Description | Length | Pieces / Pkg |
|-----------|-------------|--------|--------------|
| A-2002.01 | left | 91 mm | 1 |
| A-2002.02 | right | 91 mm | 1 |

Guides for Spiral Cutters (incl. Screw)



A-2001.01

A-2001.02



A-2001.03

A-2001.04

| Art. No. | Description | Pieces / Pkg |
|-----------|-------------------------------------|--------------|
| A-2001.01 | left, 50° | 1 |
| A-2001.02 | right, 50° | 1 |
| A-2001.03 | left, 40° | 1 |
| A-2001.04 | right, 40° | 1 |
| A-2001.05 | screw for guides for spiral cutters | 1 |

K-Wire Guide Ø 2.0 mm



| Art. No. | Description | Length | Pieces / Pkg |
|----------|---------------------|--------|--------------|
| A-2000 | for K-wire Ø 2.0 mm | 131 mm | 1 |

Drill Guide, Cortex Opening for Blade



| Art. No. | Description | Length | Pieces / Pkg |
|----------|-------------|--------|--------------|
| A-2924 | for A-3933 | 132 mm | 1 |

Handle for Spiral Blade



| Art. No. | Length | Pieces / Pkg |
|----------|--------|--------------|
| A-2003 | 170 mm | 1 |

Twist Drills



A-3931



A-3933

| Art. No. | STERILE | System Size | Ø | Stop | Length | Shaft End | Pieces / Pkg |
|----------|---------|-------------|------------------------|-------|--------|-------------------|--------------|
| A-3931 | A-3931S | 3.5 | 3.0 | 70 mm | 150 mm | AO Quick Coupling | 1 |
| A-3933 | A-3933S | 3.5 | 3.6 (for gliding hole) | 30 mm | 126 mm | AO Quick Coupling | 1 |

K-Wires, Stainless Steel



| Art. No. | STERILE | Ø | Description | Length | Pieces / Pkg |
|-----------|--------------|--------|-------------|--------|--------------|
| A-5040.61 | | 2.0 mm | trocar | 150 mm | 10 |
| | A-5040.61/2S | 2.0 mm | trocar | 150 mm | 2 |
| A-5042.61 | | 2.0 mm | lancet | 150 mm | 10 |
| | A-5042.61/2S | 2.0 mm | lancet | 150 mm | 2 |

Drill Guide



| Art. No. | System Size | Length | Pieces / Pkg |
|----------|-------------|--------|--------------|
| A-2920 | 3.5 | 171 mm | 1 |

Drill Sleeve, Self-Holding



| Art. No. | System Size | Length | Pieces / Pkg |
|----------|-------------|--------|--------------|
| A-2921 | 3.5 | 50 mm | 1 |

Depth Gauge



| Art. No. | System Size | Length | Pieces / Pkg |
|----------|-------------|--------|--------------|
| A-2930 | 3.5 / 4.0 | 210 mm | 1 |

Handles with Quick Connector



| Art. No. | Description | Length | for Shaft End | Pieces / Pkg |
|----------|-------------|--------|-------------------|--------------|
| A-2074 | | 145 mm | AO Quick Coupling | 1 |
| A-2075 | T-Handle | 81 mm | AO Quick Coupling | 1 |

Mallet, Slotted



| Art. No. | Length | Pieces / Pkg |
|----------|--------|--------------|
| A-2004 | 215 mm | 1 |

Screwdriver Blades, Self-Holding



| Art. No. | System Size | Description | Length | Shaft End | Pieces / Pkg |
|----------|-------------|-------------|--------|-------------------|--------------|
| A-2911 | 3.5 / 4.0 | HD15 | 80 mm | AO Quick Coupling | 1 |
| A-2913.1 | 3.5 / 4.0 | HD15 | 155 mm | AO Quick Coupling | 1 |

Sleeve for Screwdriver Blade



| Art. No. | System Size | Description | Length | Pieces / Pkg |
|----------|-------------|-------------|--------|--------------|
| A-2913.2 | 3.5 / 4.0 | HD15 | 91 mm | 1 |

Cases, Trays

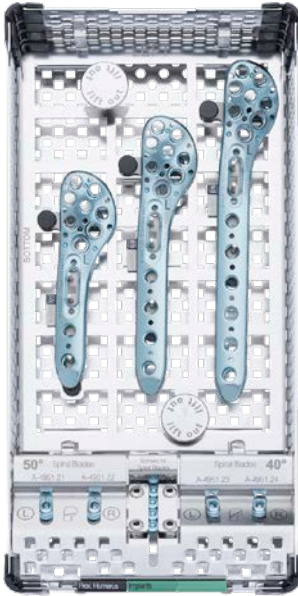

A-6605.001 with A-6605.005
(excl. implants)



A-6605.006
(excl. implants)

| Art. No. | Description | Dimensions (W × L) | Pieces / Pkg |
|------------|--|--------------------|--------------|
| A-6605.001 | implant case APTUS proximal humerus 3.5 | 120 × 240 mm | 1 |
| A-6605.005 | plate tray APTUS proximal humerus, left plates | 114 × 178 mm | 1 |
| A-6605.006 | plate tray APTUS proximal humerus, right plates | 114 × 178 mm | 1 |
| M-6706 | lid for implant and instrument case 120 × 240 mm | 120 × 240 mm | 1 |



A-6605.007
(excl. implants)

| Art. No. | Description | Dimensions (W × L) | Pieces / Pkg |
|------------|--|--------------------|--------------|
| A-6605.007 | implant case APTUS proximal humerus 3.5, XL plates | 240 × 240 mm | 1 |
| M-6707 | lid for implant and instrument case 240 × 240 mm | 240 × 240 mm | 1 |

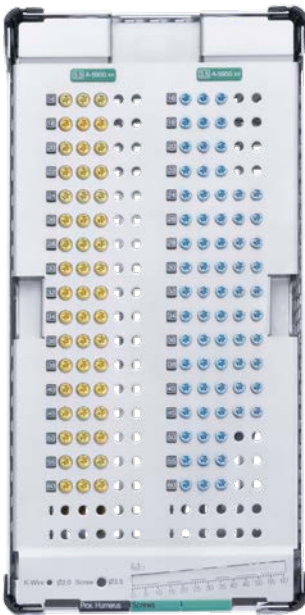

A-6605.010 with A-6605.011
(excl. implants)

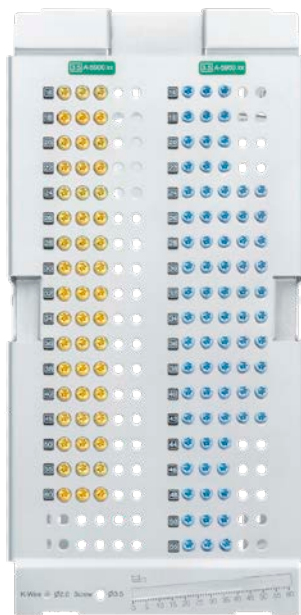

A-6605.012
(excl. implants)

| Art. No. | Description | Dimensions (W x L) | Pieces / Pkg |
|------------|---|--------------------|--------------|
| A-6605.010 | implant case APTUS proximal humerus 3.5 screws | 120 x 240 mm | 1 |
| A-6605.011 | screw tray APTUS proximal humerus 3.5 | 114 x 232 mm | 1 |
| A-6605.012 | screw tray APTUS proximal humerus 3.5, 2 mm steps | 114 x 232 mm | 1 |
| M-6706 | lid for implant and instrument case 120 x 240 mm | 120 x 240 mm | 1 |



A-6605.020 with A-6605.021
(excl. instruments)

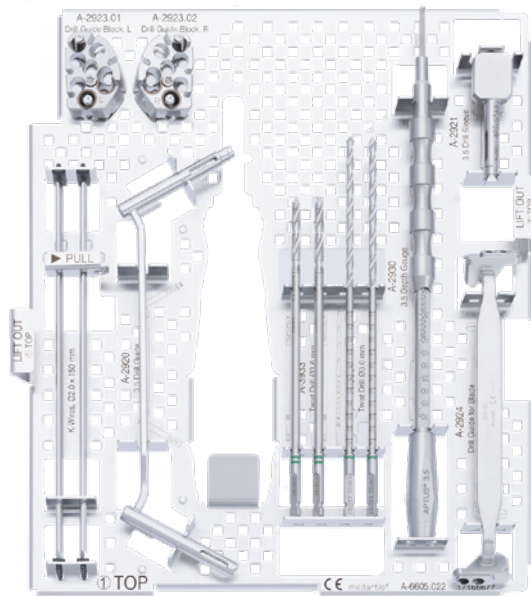

A-6605.022
(excl. instruments)

| Art. No. | Description | Dimensions (W x L) | Pieces / Pkg |
|------------|--|--------------------|--------------|
| A-6605.020 | instrument case APTUS proximal humerus 3.5 | 240 x 240 mm | 1 |
| A-6605.021 | instrument tray APTUS proximal humerus "2" | 234 x 234 mm | 1 |
| A-6605.022 | instrument tray APTUS proximal humerus "1" | 234 x 234 mm | 1 |
| M-6707 | lid for implant and instrument case 240 x 240 mm | 240 x 240 mm | 1 |

Storage and Transportation

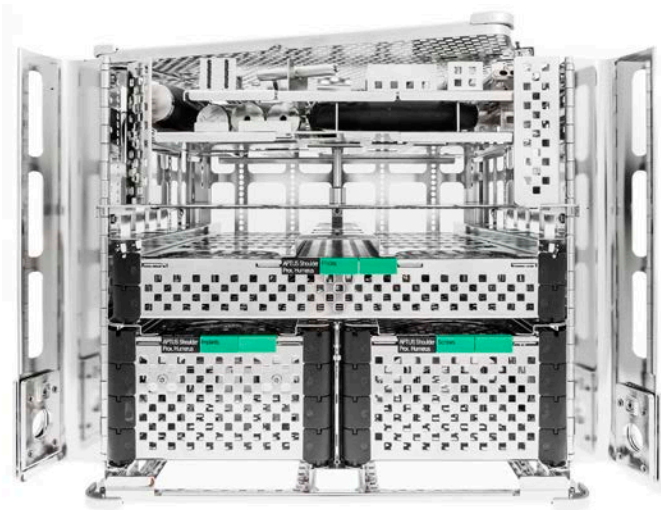

A-6610.30 with A-6605.007, A-6605.001 and A-6605.011
(excl. containers)

| Art. No. | Description | Dimensions (L x W x H) | Pieces / Pkg |
|------------|---|------------------------|--------------|
| A-6610.30* | storage container for APTUS proximal humerus system | 265 x 257 x 238 mm | 1 |
| A-6611* | lid for A-6610.xx | 265 x 257 mm | 1 |
| M-6720 | holding rack for implant and instrument cases, for case 240 x 240 mm | 252 x 243 x 245 mm | 1 |

* Not available in all countries.

Articles available on request

A-5040.61/1

A-5042.61/1

R_SHOULDER-01010001_v0 / © 2021-08, Medartis AG, Switzerland. All technical data subject to alteration.

MANUFACTURER & HEADQUARTERS

Medartis AG | Hochbergerstrasse 60E | 4057 Basel / Switzerland
P +41 61 633 34 34 | F +41 61 633 34 00 | www.medartis.com

SUBSIDIARIES

Australia | Austria | Brazil | China | France | Germany | Japan | Mexico | New Zealand | Poland | Spain | UK | USA

For detailed information regarding our subsidiaries and distributors, please visit www.medartis.com

CE
0197

CE

Disclaimer: This information is intended to demonstrate the Medartis portfolio of medical devices. A surgeon must always rely on her or his own professional clinical judgement when deciding whether to use a particular product when treating a particular patient. Medartis is not giving any medical advice. The devices may not be available in all countries due to registration and/or medical practices. For further questions, please contact your Medartis representative (www.medartis.com). This information contains CE-marked products.

For US only: Federal law restricts this device to sale by or on the order of a physician.